

STANDARD

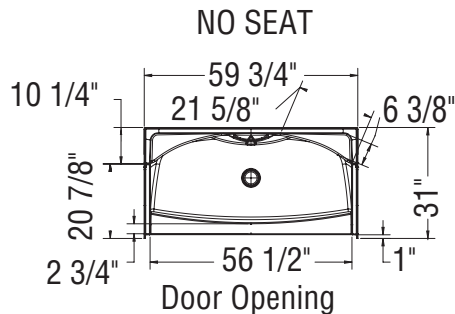

RIGHT SEAT SHOWN LEFT SEAT SYMMETRICAL

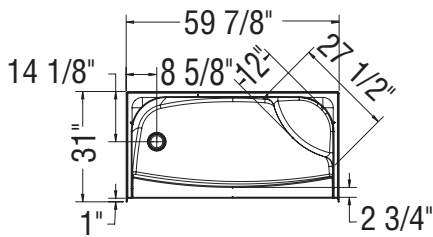

NOT ABOVE-THE-FLOOR

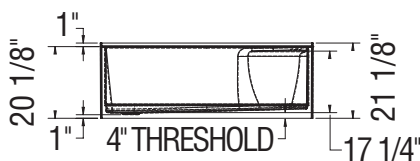

ABOVE-THE-FLOOR

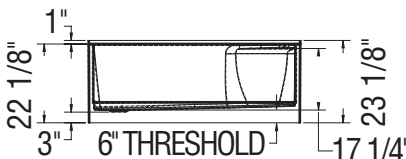

REINFORCEMENT BACKING

OPTION 20212-L Shown
OPTION 20212-R Symetrical

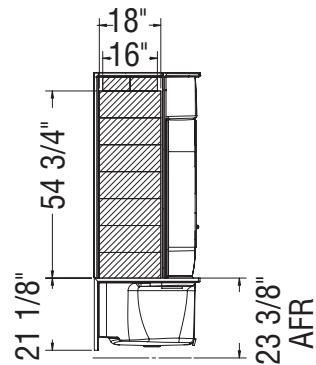

OPTION 20212-B

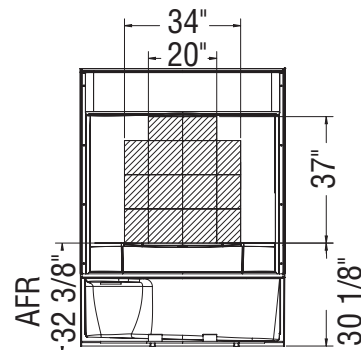

GRAB BARS

OPTION 20203

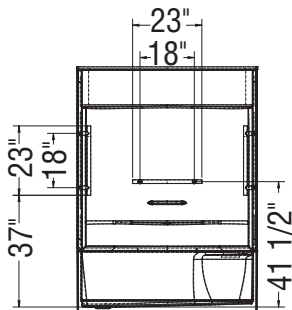

OPTION 20204

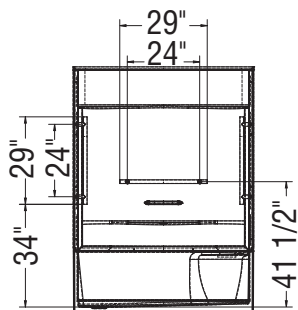

OPTION 20203-20204

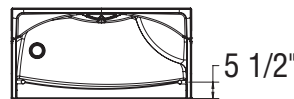

All dimensions are approximate. Structure measurements must be verified against the unit to ensure proper fit.