

CONTECA™ heat energy meter

© Copyright 2020 Caleffi

7504 series

INSTALLATION AND COMMISSIONING MANUAL



Product range

CONTECA Heat meter kit, complete with heat meter, two integral temperature sensors, two sensor holder bodies and rotary pulse flow meter, and:

7504_0A series	male NPT pipe connections	sizes 1/2", 3/4" & 1" with unions
7504_3A series	female NPT pipe connections	sizes 1", 1 1/4" & 1 1/2" with unions
75041_A	ANSI Class 150 RF flange connections	sizes 2 1/2" to 8"
7504_6A series	press pipe connections	sizes 1/2", 3/4" & 1" with unions
7504_9A series	sweat pipe connections	sizes 1/2", 3/4" & 1" with unions
Code 750450	Datalogger	
Code 755052	Modbus-to-BACnet gateway	

Technical specifications

Heat meter:

Materials: -Housing & cover: ABS, RAL 9004
 Power supply: 24 VAC, 50/60 Hz, 1W
 Data transmission: 2-wire RS485; selectable Modbus or M-bus (for use with datalogger)
 Ambient temperature: 40 – 113°F (4 – 45°C)
 Environmental rating (protection class): NEMA 3S (IP 54)
 Pulse inputs: Class 1B per EN 1434-2

Temperature sensors:

Cable length*: 26 1/4 ft. (8 m)
 Sensor type: NTC matched
 Temperature range: heating mode: 50 – 195°F (10 – 90°C)
 Temperature range: cooling mode: 35 – 77°F (2 – 5°C)
 Temperature sensitivity: < 0.1°F
 Temperature sensor thermowell: Stainless steel
 Sensor holder body: Brass
 Max. working pressure: 150 psi (10 bar)

*Extra length of 26 1/4' cable must be carefully coiled and mounted in a safe place. Do not cut or splice.

Function

CONTECA™ is a direct heat energy meter designed to measure instantaneous and recorded history of thermal energy usage in residential and commercial buildings, for heating only, cooling only, or both heating and cooling.

The CONTECA meter features an 8-digit liquid crystal display that enables easy reading of BTU consumed as well as a range of technical data indicating equipment operating status and data logging.

Each CONTECA includes a heat meter with an electronic calculator and user interface, two temperature sensors, sensor holder bodies, fittings included. The rotary pulse flow meter comes with the CONTECA meter kit. In addition to the two temperature inputs and flow meter input, 4 additional pulse inputs are available for optional equipment monitoring. Data logging is available using the CONTECA datalogger via RS-485 connection. The CONTECA is easy to install and commission, and is certified to ASTM E3137/E3137M-17 Standard Specification for Heat Meter Instruments by ICC-ES, and Directive 2014/32/EU EN 1434 (MI 004).

The CONTECA heat meter has integral RS485 protocol 2-wire communication for remote access and configuration. M-bus protocol is used with the CONTECA Datalogger (default). The protocol can be changed to Modbus when using the CONTECA heat meter directly with a Modbus BAS or when using the Modbus-to-BACnet gateway for communication to a BACnet BAS. Up to 250 CONTECA meters can connect to one CONTECA data logger.

Flow meters:

Flow meter type:
 Single jet (1/2" - 1" to 10 gpm); Multiple jet (1" to 1 1/2" to 45 gpm);
 Woltman (2 1/2" - 8" to 1000 gpm)
 Body material: Brass (1/2" - 1 1/2"); Powder-coated cast iron (2 1/2" - 8")
 Pulse output: class OA-OC in accordance with EN 1434-2
 Body threads (brass bodies): ISO 228 male straight
 Piping connections: Brass: Dual unions, tailpieces NPT, sweat, press
 Cast iron: ANSI Class 150 RF flanged
 Max. working pressure: Brass & Cast Iron: 235 psi (16 bar)
 200 psi (13 bar) max. for press models
 Maximum fluid temperature: 265°F (130°C)

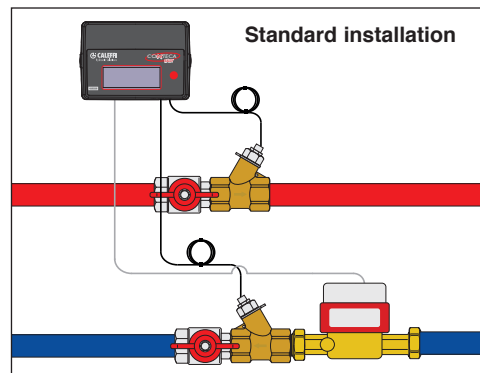



SAFETY INSTRUCTION

This safety alert symbol will be used in this manual to draw attention to safety related instructions. When used, the safety symbol means **ATTENTION! BECOME ALERT! YOUR SAFETY IS INVOLVED! FAILURE TO FOLLOW THESE INSTRUCTIONS MAY RESULT IN A SAFETY HAZARD.**



WARNING: This product can expose you to chemicals including lead, which is known to the State of California to cause cancer and birth defects or other reproductive harm. For more information go to www.P65Warnings.ca.gov.

AVERTISSEMENT: Ce produit peut vous exposer à des produits chimiques comme le plomb, qui est connu dans l'État de Californie pour causer le cancer, dommages à la naissance ou autre. Pour plus d'informations rendez-vous www.P65Warnings.ca.gov.



WARNING: Caleffi shall not be liable for damages resulting from stress corrosion, misapplication or misuse of its products.

AVERTISSEMENT: *Caleffi ne sera pas responsable des dommages résultant de la corrosion sous tension, d'une mauvaise application ou d'une mauvaise utilisation de ses produits.*



CAUTION: All work must be performed by qualified personnel trained in the proper application, installation, and maintenance of systems in accordance with all applicable codes and ordinances.

ATTENTION: Tous les travaux doivent être effectués par du personnel qualifié formé à la bonne application, installation et maintenance des systèmes conformément aux codes et règlements locaux.



CAUTION: If the heat meter is not installed, commissioned and maintained properly, according to the instructions contained in this manual, it may not operate correctly and may endanger the user.

ATTENTION: Si le compteur d'énergie thermique, n'est pas installé, mis en service et entretenu correctement, selon les instructions contenues dans ce manuel, il peut ne pas fonctionner correctement et peut mettre en danger l'utilisateur.



CAUTION: Make sure that all the connecting pipework is water tight

ATTENTION: S'assurer que tous les raccordements sont étanches.



CAUTION: When making the water connections, make sure that the pipework connecting the CONTECA heat meter is not mechanically overstressed. Over time this could cause breakages, with consequent water losses which, in turn, could cause harm to property and/or people.

ATTENTION: Lorsque vous effectuez les raccordements d'eau, assurez-vous que la tuyauterie reliant le CONTECA compteur d'énergie thermique n'est pas mécaniquement des overstressed. Au fil du temps, ceci pourrait causer des ruptures, avec pour conséquence des pertes en eau qui, à leur tour, peuvent causer des dommages à la propriété et/ou les gens.



CAUTION: Water temperatures higher than 100°F (38°C) can be dangerous. During the installation, commissioning and maintenance of the CONTECA heat meter, take the necessary precautions to ensure that such temperatures do not endanger people.

ATTENTION: Les températures de l'eau supérieure à 100°F (38°C) peut être dangereux. Au cours de l'installation, mise en service et l'entretien de le réducteur de pression, le CONTECA compteur d'énergie thermique, prendre les précautions nécessaires afin de s'assurer que de tels températures ne compromettent pas les gens.



CAUTION: To prevent any damage which will cause the heat meter to not operate correctly, treat highly aggressive water before entering the heat meter. Be sure water hardness is less than 10 grains.

ATTENTION: Pour prévenir tout dommage qui provoque le compteur d'énergie thermique à ne pas fonctionner correctement, le traitement de l'eau très agressive avant d'entrer dans la vanne le compteur d'énergie thermique. Assurez-vous que la dureté de l'eau est inférieure à 10 grains.



CAUTION: IMPORTANT: Risk of electric shock. The back panel and heat meter contain live circuits. Cut off the electric supply before performing work. Failure to follow these instructions may result in injury of persons or damage to property.

ATTENTION: Risque de choc électrique. Le fond d'armoire et le compteur d'énergie thermique sont sous tension. Couper l'alimentation électrique avant toute intervention. Le non respect de ces règles de sécurité peut entraîner des dégâts matériels et/ou des blessures aux personnes.

**LEAVE THIS MANUAL WITH THE USER.
LAISSER CE MANUEL AVEC L'UTILISATEUR**

Flow rates

Code*	Size	Flow meter type & code	Liters per pulse	Minimum Flow rate (gpm)	Maximum flow rate (gpm)
		Single jet			
75044xA	1/2"	750405	1	0.25	10
75045xA	3/4"				
75046xA	1"				
		Multiple jet			
750463A	1"	750406	2.5	0.3	15
750473A	1 1/4"	750407	10	0.5	25
750483A	1 1/2"	750408		1	45
		Woltman			
750410A	2 1/2"	750410	100	11	110
750411A	3"	750411		14	140
750412A	4"	750412		22	220
750413A	5"	750413		35	350
750414A	6"	750414		88	880
750415A	8"	750415	1,000	100	1000

Flow rate range for combined flow meter and 2 sensor holder bodies.

*position x for codes with Single jet flow meters as follows:

0=NPT male; 3=NPT female; 6=press; 9=sweat

NOTE: press models limited to 200 psi max. working pressure.

Hydraulic characteristics

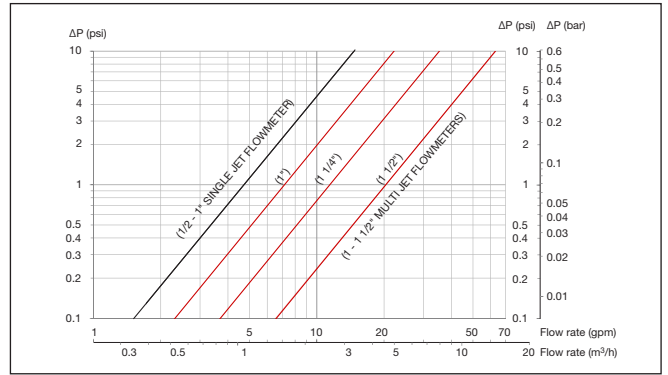

Cv	Single jet flow meter			Multiple jet flow meter		
	1/2"	3/4"	1"	1"	1 1/4"	1 1/2"
	5.0			6.8	11.7	19.6

Flow rate range for combined flow meter and 2 sensor holder bodies.

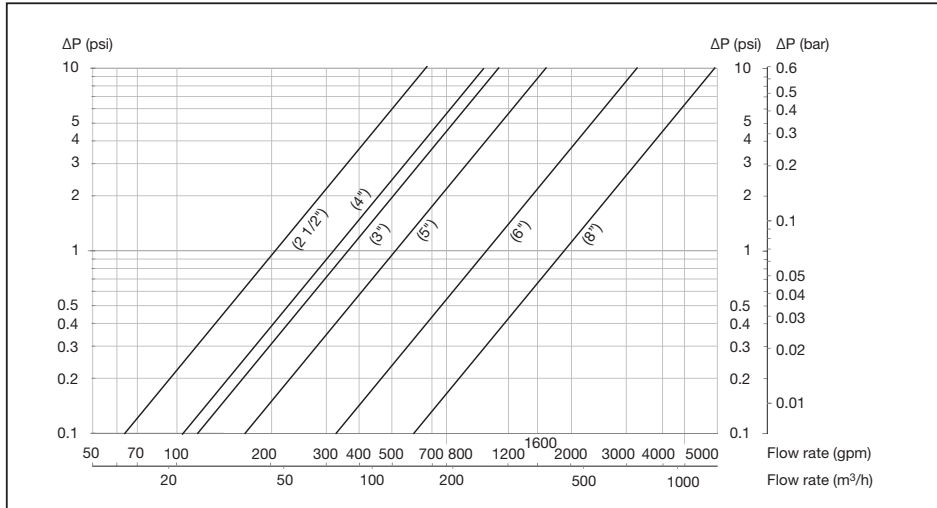

Cv	Woltman meter					
	2 1/2"	3"	4"	5"	6"	8"
	208	370	330	522	1,030	1,970

Flow rate range for combined flow meter and 2 sensor holder bodies. Note, the 4" meter flow capacity is lower than the 3" meter.

Dimensions

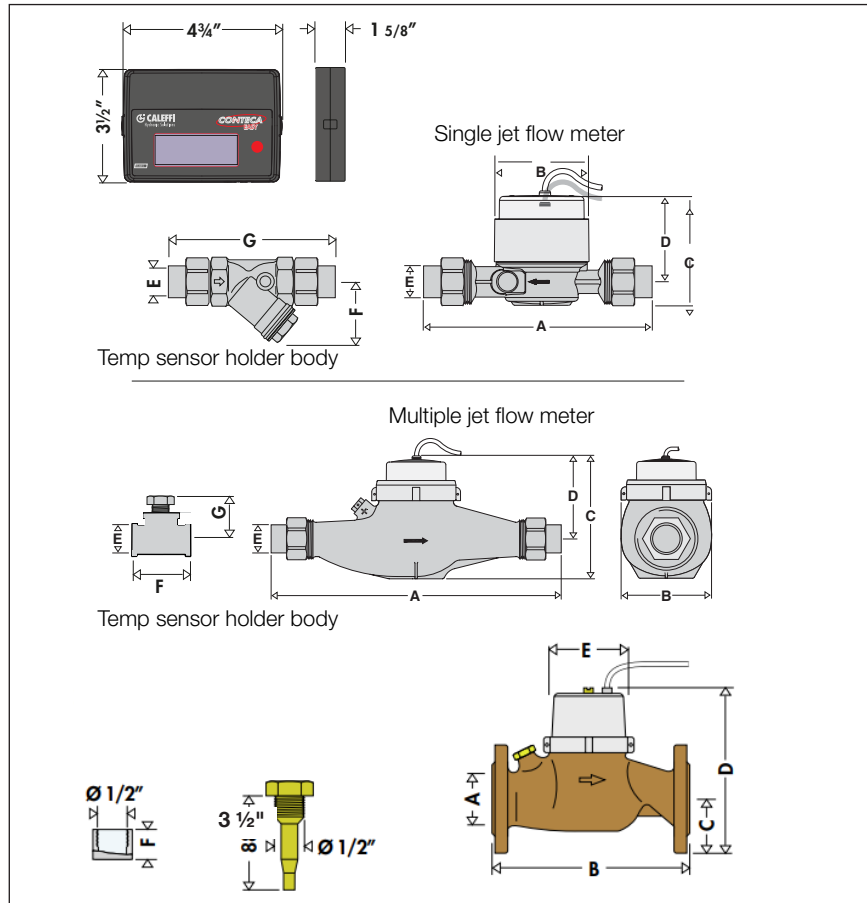

Code	A	B	C	D	ends*	E	F	G	Wt (lb)	
750449A	6 7/8"	3 1/8"	4 1/4"	3 1/2"	sweat	1/2"	7 1/4"	2"	6.2	
750440A	8 3/8"				8 3/4"					
750446A	7 1/2"				4 7/8"					
750459A	7 3/8"				7 3/4"					
750450A	7 5/8"				8"					
750456A	7 7/8"				8 1/4"					
750469A	8 5/8"				9"					
750460A	8 3/8"				8 3/4"					
750466A	8 5/8"				8 1/2"					
750405A	5 1/8"				1"	5 1/8"	6.0			
750463A	12 1/4"	4"	5 3/8"	3 3/4"	fnpt	1"	5 1/8"	2 1/16"	11.5	
750473A	12 1/4"	4"	5 3/8"	3 3/4"		1 1/4"	5 7/8"	2 3/8"	12.1	
750483A	17 1/4"	5 1/4"	6 7/16"	4 5/8"		1 1/2"	5 5/8"	2 5/16"	18.7	
750410A	2 1/2"	7 7/8"	3 3/8"	8 7/8"	flange	6"	1 5/16"	27	29	
750411A	3"	8 7/8"	3 3/4"	9 1/4"		6"	1 5/16"			
750412A	4"	9 7/8"	4 5/16"	12 1/4"		8 5/8"	1"			44
750413A	5"	9 7/8"	5"	12 3/4"		9 7/8"	3/4"			51
750414A	6"	11 13/16"	5 5/16"	15"		11 1/4"	3/4"			88
750415A	8"	13 13/16"	6 1/2"	16 1/8"		13 3/8"	3/4"			110

*end connections are the same for the flowmeter and sensor holder bodies for each code, except for flanged codes. Example: code 750449A has union sweat ends on both the flow meter and the sensor holder bodies.

NOTE: press models limited to 200 psi max. working pressure.

Installation

To ensure accurate energy measurement, plan the installation for easy initial installation, commissioning and future maintenance. Install the flow meter in a location that will be easy to perform periodic maintenance. Locate the sensors (inserted in provided brass sensor holder bodies) and the flow meter in straight runs of unobstructed pipe as long as possible.

Install shut-off valves upstream and downstream of the flow meter to aid installation and maintenance. Install a clean strainer or other filtering device upstream of the flow meter.

Install the temperature sensor thermowells into the brass sensor holder bodies, following the respective flow directions and properly located for the supply (red label) and return (blue label) positions. The corresponding supply and return pipes must be integral to the same flow rate as measured by the flow meter.



Do not modify the length of the sensor cables. The sensor cables must not be spliced for shortening or extending because this will adversely affect functionality and accuracy.

The flow meter must be installed on the return pipe and in the horizontal position with the turbine axis vertical, following the flow direction indicated by the arrow on the body.



After installing all CONTECA heat meter kit components follow the electrical connections instructions on page 6.

When all work is completed all components need to be lead sealed, follow instructions on pages 10.

1) Diagram of system with metering on manifold with several stages.

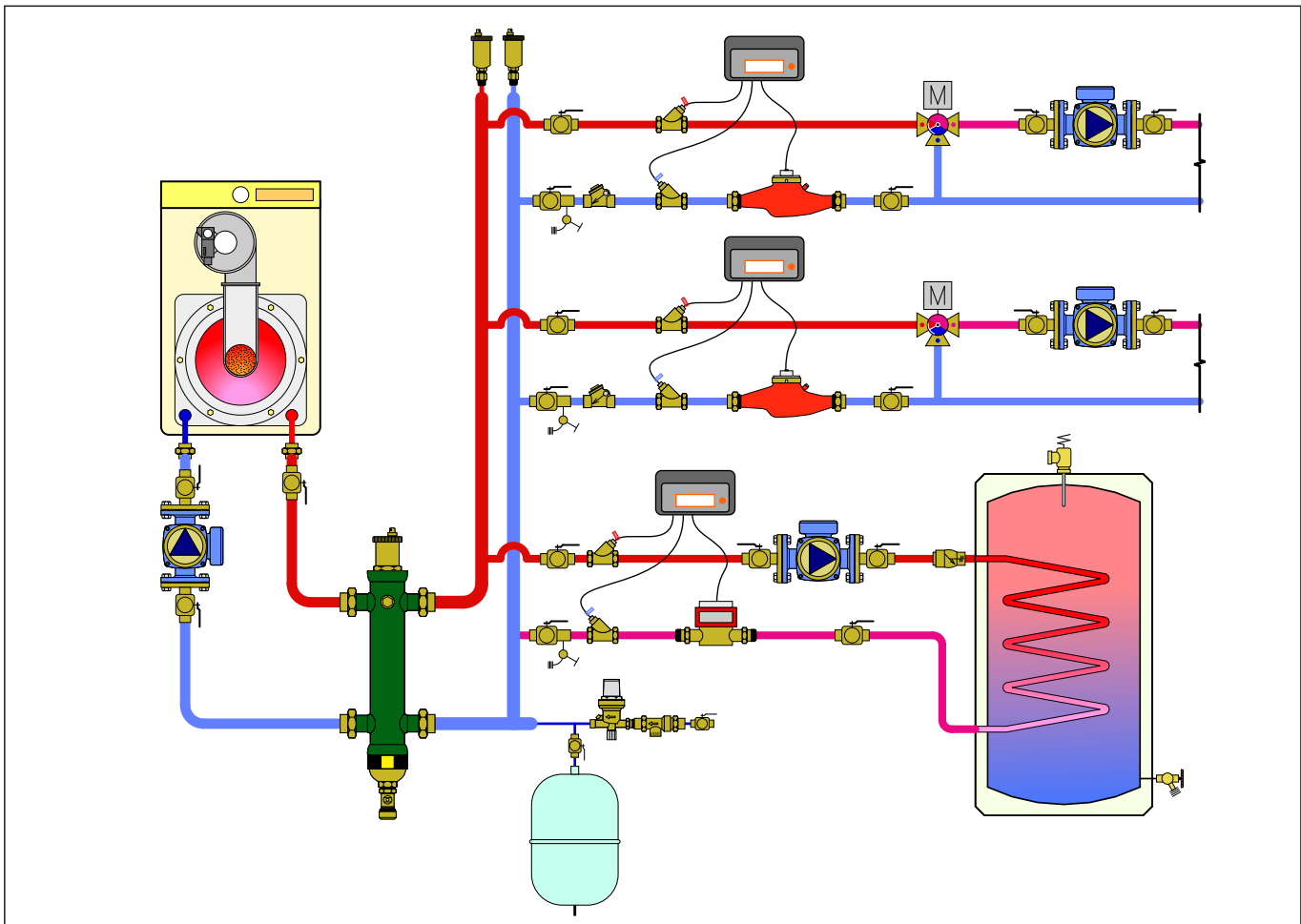

2) Diagram of user circuit - Control with 2-way zone valves

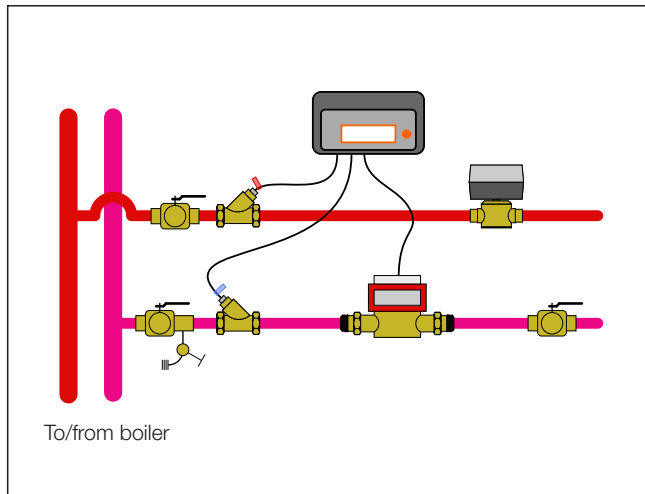

Maintenance

Filter cleaning

It is necessary to keep clean the strainer or other filter device installed in the flow circuit in a position that protects the flow meter.

By observing the instantaneous flow rate and temperature difference values (flow rate significantly reduced in relation to the nominal value and temperature drop significantly increased), filter clogging can be easily detected for cleaning.

CONTECA heat meter electrical connections

When mounting in a box or directly on a wall, use the screws provided in the package, insert them in the slots **A** in order to level the device correctly.

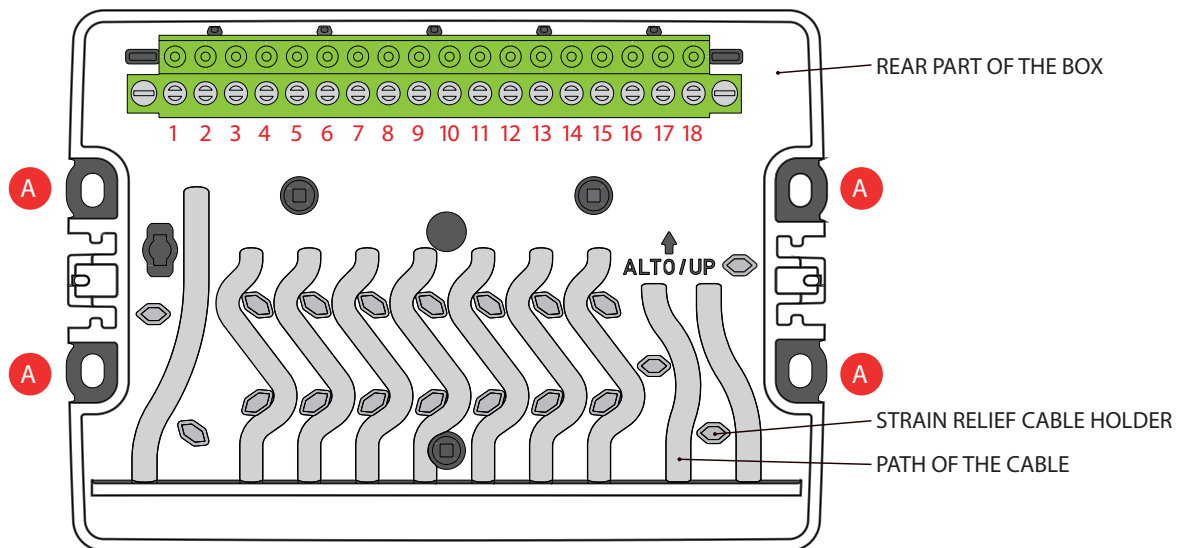

Pins	Description
1 - 2	OUT 2 - Open collector pulse output for COOLING units. GND=2 / duration 120 ms / Vmax 24V (dc) - 50 mA
2 - 3	OUT 1 - Open collector pulse output for HEATING units. GND=2 / duration 120 ms / Vmax 24V (dc) - 50 mA
4	NOT used
5 - 6	IN 4 - 4th pulse input (generic). GND=6
6 - 7	IN 3 - 3rd pulse input (generic). GND=6
8 - 9	IN 2 - Pulse input for optional DCW. GND=9
9 - 10	IN 1 - Pulse input for optional DHW. GND=9
11 - 12	Pulse input for the heating volume meter
13 - 14	Digital input (Dry contact: it must be a volt free contact)
15 - 16	Power supply 24 V (ac) 50 Hz - 1W
17 - 18	Transmission Bus RS-485 / RS-485 A=18 (Rx) RS-485 B=17 (Tx)

• Power supply and energy flow meter inputs

- 15 - 16 Power supply 24 V (AC).
- 11 - 12 Flow meter pulse input.

The 24 V (AC) electric supply line should be used solely for the heat meters.

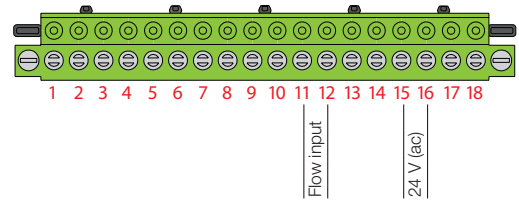

• Network connection

In the case of data transmission via bus use the following terminals:

- 17 - 18 Polarized transmission bus - Bus RS-485
- 17 Tx (RS-485-B) 18 Rx (RS-485-A)

For the transmission bus, use a shielded 2-conductor AWG 22.

Note: The transmission polarity must be fully observed.

(Pin 4 is not used)

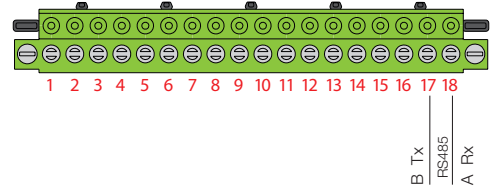

• Energy pulse outputs

- 2 - 3 Heating units output to remote data gathering device (kBTU)
- 1 - 2 Cooling units output to remote data gathering device (kBTU)

Output specifications:

- 1 PULSE = 1 kBTU - open collector contact
- Pulse duration: 120 ms

Max. frequency - 1 Hz

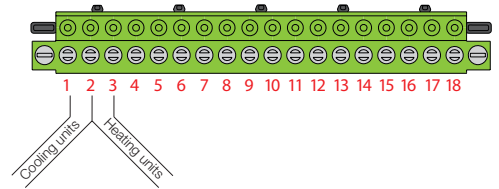

• Domestic hot and cold water inputs

Separately sourced domestic water meter with pulse outputs.

- 8 - 9 Pulse input for optional DCW (gal)
- 9 - 10 Pulse input for optional DHW (gal)

1 PULSE = 1 gal

Pulse duration: 120 ms

Max. frequency - 1 Hz

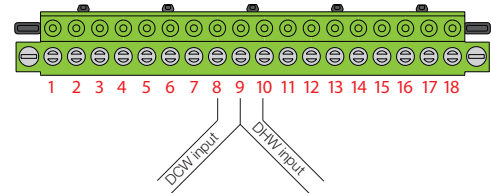

• Additional pulse inputs

ie: Watt Hour meter - Gas meter

The metering system must be provided with a volt free contact and the weight of the pulse must be indicated.

- 1 Pulse = 0.1 kWh electric energy
- 1 Pulse = 1 Nm³ gas

- 6 - 7 3rd pulse input
- 5 - 6 4th pulse input

Minimum pulse duration: 120 ms

Max. frequency - 1 Hz

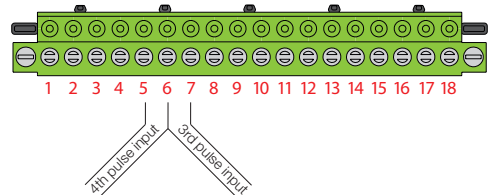

• Digital input

The digital input must be potential free (class IB).

- 13 - 14 Connection of the auxiliary microswitch of the zone valve (ON/OFF status). When in the ON status an internal register logs the hours of circuit operation. This input does not affect the meter calculations or function.

Notes: - Each 7504 series device is supplied with a tamper-proof lead sealing kit for the temperature probes and for the plastic electronics box.

- Make the cables to pass through the cable fairleads and the strain relief cable holders.
- The basic function of the partition is to protect the electronics card from dust and jets of water.

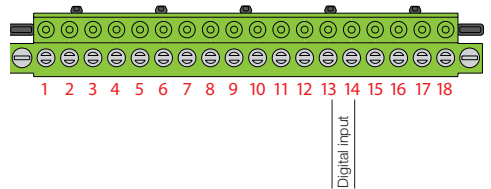

Operating information

The accumulated energy amounts are retrieved in a non-volatile memory device (EEPROM) each time the units of measurement are completed (1 BTU) and, at the same time, this increase causes the display to be updated (see "User information cycle").

User information cycle

The CONTECA heat meter has a liquid crystal display. The display is activated by pressing the button on the front. Scroll through the various information windows by repeatedly pressing the button briefly. In some views, holding the button for several seconds allows additional information to be shown on the display.

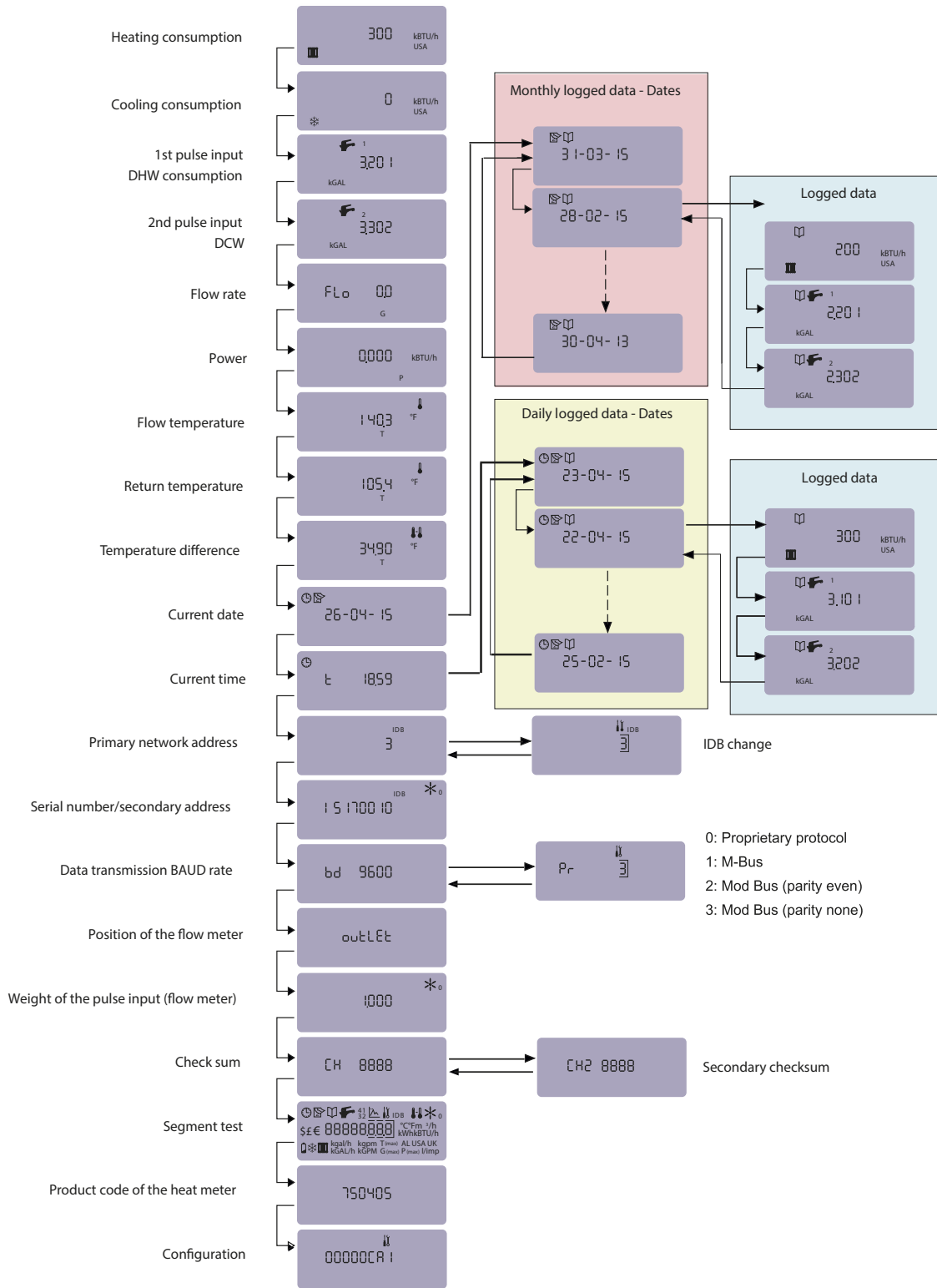

Important!

→ press the front button for 10 seconds and release the button

Contact Caleffi for the special procedure to configure CONTECA for measuring heat energy of fluids other than water, such as glycol.

Test instructions

The 7504 series heat meter is equipped with a quick output test feature, located inside the plastic box. Access this, by removing the seal and take out the screws.

The PCB has a button on the very edge of the right-hand side (figure 1) which can be used to select the technical menu.

Figure 1

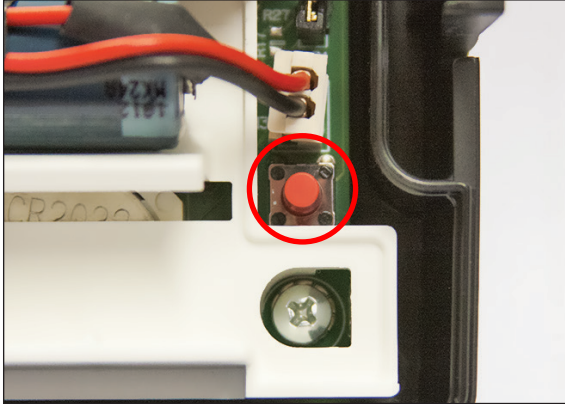

Use the button (push) on the display front panel to scroll through the screens. The unit of measurement for the energy, when in test mode, is kBTU/h (figure 2).

Figure 2



mean temp °F	water (κ)	50% propylene glycol (κ)
40	8.37150	7.37765
60	8.32908	7.42281
80	8.28925	7.46177
100	8.25115	7.49449
120	8.21388	7.52096
140	8.17651	7.54117
160	8.13813	7.55510
180	8.09777	7.56276
200	8.05449	7.56414

Operating specifications

- 1) The software used to control the metering process, in order to avoid energy metering under non-operating conditions, implements the following principle, based on calculated energy used depending on a specific supply temperature value (FT):

Heating metering is activated for a FT value >71.6°F (factory set).

The set values may be modified by an authorized technician on request.

- 2) The software used to control the metering process also operates on the principle that consumption processing depends on the presence of a minimum temperature difference in order to further safeguard against unnecessary measurements or minimal unwanted metering deriving from tolerances in temperature detection a dead band of 0.7°F is therefore defined.

- 3) The software used to control the metering process also requires the flow meter to be installed on the return pipe. Authorized technicians can, on request, adapt the configuration set so as to position the flow meter on the supply pipe, via RS485 protocol.

The pulse input can be simulated by jumpering pins 11 - 12 (figure 3). The maximum input frequency is 1 Hz.

Figure 3

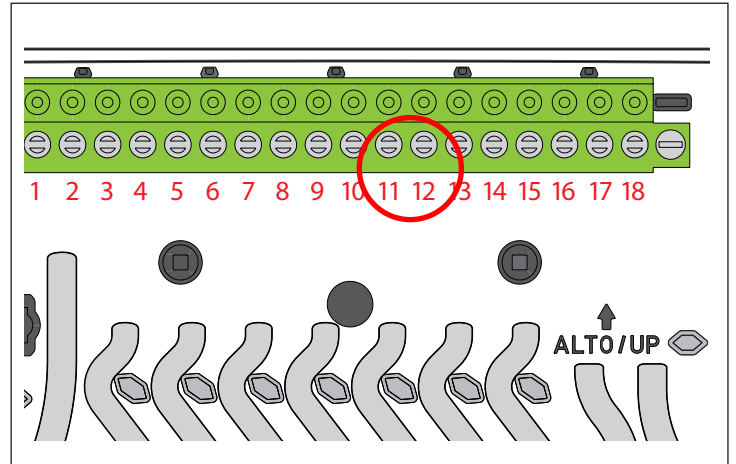

The temperature sensors, directly connected to the heat meter, inseparable from the electronics circuit, may be placed in a thermostatic bath, observing the temperature range 50–195°F and a ΔT between 5–145°R.

The energy increases on the basis of the following equation:

$$E = \kappa \cdot V(0.26417205) \cdot L \cdot \Delta T \text{ (BTU)}$$

- E = energy (BTU)
- κ = factor from table [BTU/lb°F]
- ΔT = temperature difference between sensors over short time increment [°F]
- V = number of pulses input to the meter over short time increment
- L = number of liters per pulse (see table on page 3 for specific flow meter)

Example: Over a period of 10 seconds you record 8 pulses from the meter, using the single jet flow meter having 1 liter per pulse, and the average temperature difference between sensors has been 12.5 °F. The fluid is water at a mean temperature of 60 °F (so K = 8.32908)

$$E = 8.32908 \cdot 8(0.26417205) \cdot 1 \cdot 12.5 = 220.031 \text{ BTU}$$

Lead sealing procedure

Temperature sensors

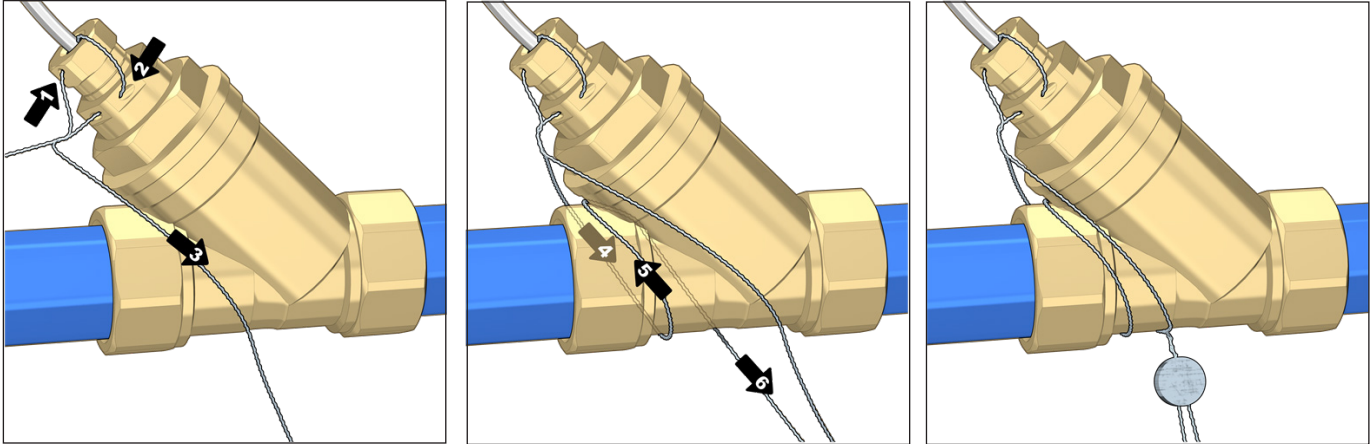

- A) Feed the steel wire through the holes in the temperature sensor fitting (1) and through the sensor fitting pocket (2) and twist it;
- B) Wind the wire tightly as shown in the picture so that, once the seal will be in place, it will be impossible to remove the sensor without either breaking the seal or cutting the wire;
- C) Twist the wire and insert the lead seal;
- D) Repeat steps D, E, F for the other temperature probe.

Heat meter

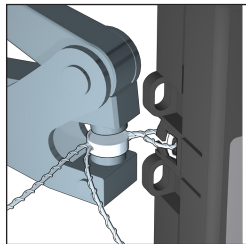

- E) Feed the steel wire through the dedicated holes on one side of the heat meter unit, twist it and insert the lead seal.
- F) Crimp the lead seals highlighted with the green circles in the picture on the right.

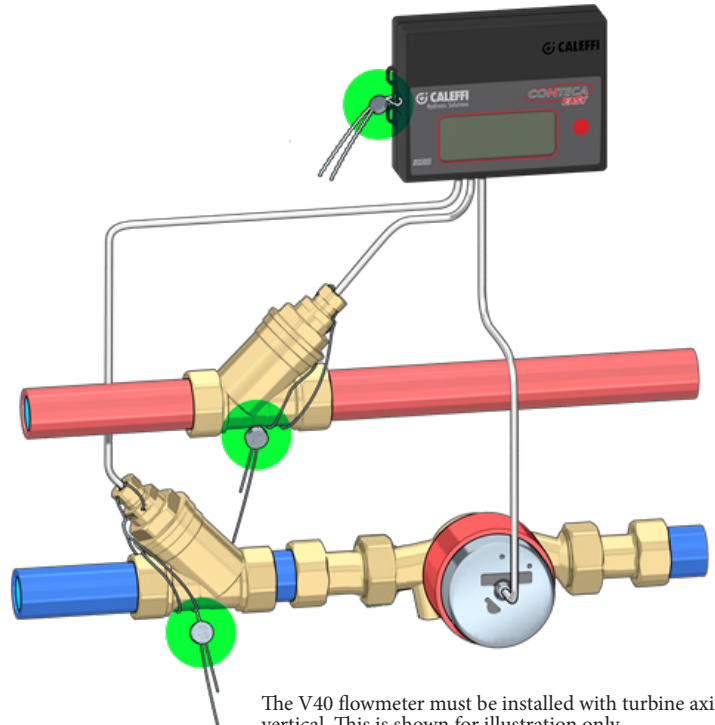

The V40 flowmeter must be installed with turbine axis vertical. This is shown for illustration only.

Page intentionally left blank

NETWORK CONFIGURATION

Building transmission network layout

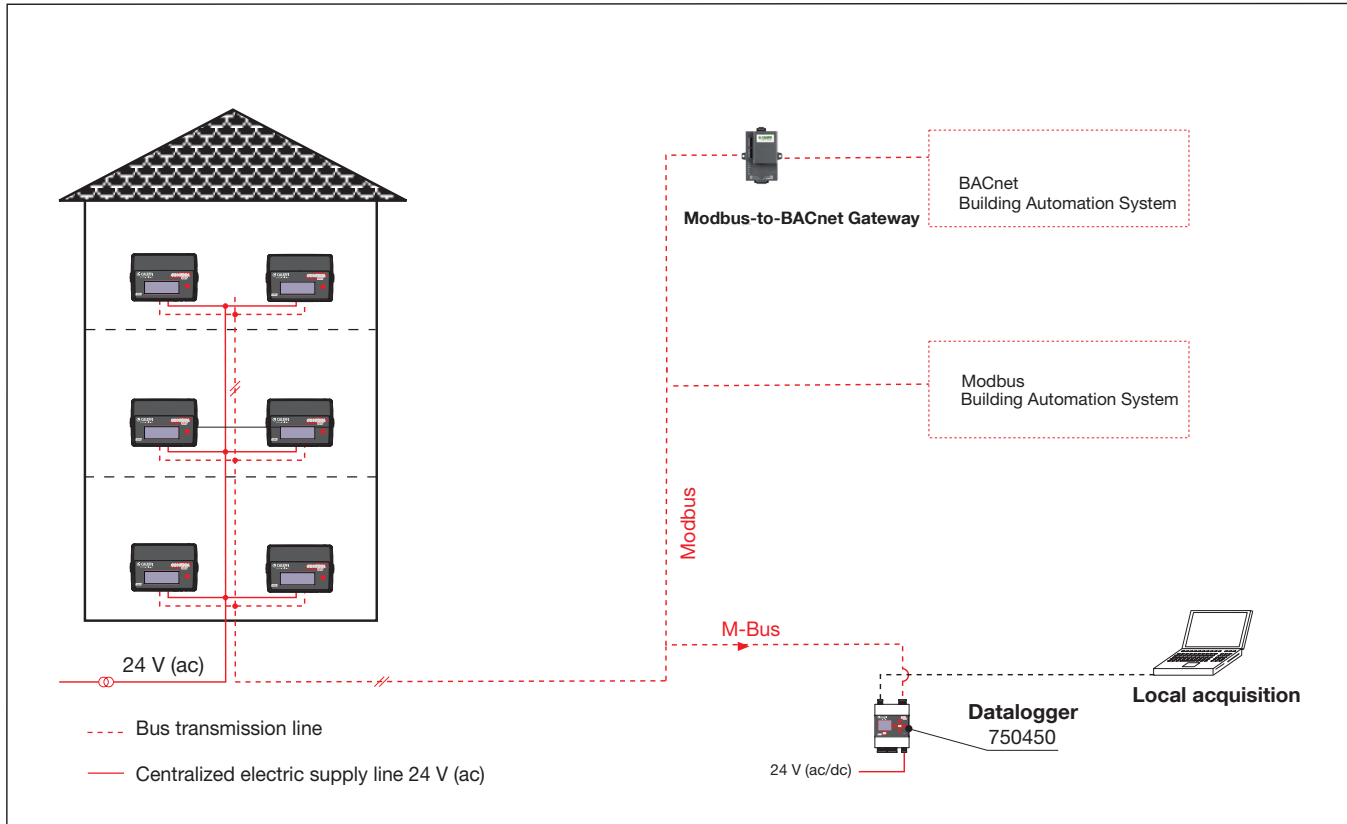

750450 CONTECA™ Datalogger

The CONTECA datalogger allows acquisition and logging of the consumption data from CONTECA heat meters via Modbus communication. The integrated browser provides logged and instantaneous data, and report generator. The CONTECA® datalogger can be set up locally via web interface by connecting a PC to one ethernet port with switch functionality.

The SMART function allows the automatic detection of the heat meters connected to the network. Data can be obtained with the automatic report generation, making the system user-friendly and reduces the number of operations to run.

Maximum number of heat meters: 250.



- Main specifications of the datalogger:
- Power supply: 24 V (dc) ±10%, 24 V (ac) - 3 W.
 - 2 Ethernet ports: ETH1 (PoE), ETH2.
 - Ambient temperature range: 32 - 122°F.
 - Mounting: on a 35 mm DIN rail (EN 60715).
 - Daily data logging: 10 years.
 - Reports: In XLS or CSV format.



**Leave this manual at the service of users for their use.
Laissez ce manuel au service des utilisateurs pour leur utilisation.**

755052 Modbus-to-BACnet gateway

Converts CONTECA controller Modbus (RS-485 serial) output communication to BACnet IP or MSTP communication.



Caleffi North America, Inc.
3883 W. Milwaukee Road
Milwaukee, WI 53208
T: 414.238.2360 F: 414.238.2366

Guide to MODBUS registers for CONTECA 7504/7507 series heat meters

© Copyright 2018 Caleffi

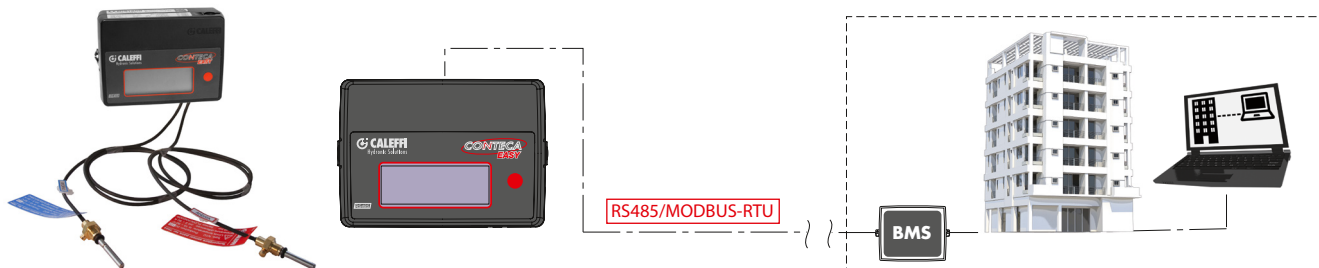

Transmission

Protocol type	BUS	Baud Rate	Data bit	Parity	Stop bit	Handshake	Unit Load
MODBUS-RTU	RS-485	9600	8	EVEN/NONE	1	None	1/8UL

MODBUS functions:

Function 0x03 - Read Holding Registers

Used to read one or more parameters (the size of every parameter is 16 bit)

The frame has the following structure:

dev. Addr.	func	start addr H	start addr L	N.regs H	N.regs L	CRC16H	CRC16L
HH	03	HH	HH	00	HH	HH	HH

dev. Addr. – Address of the device on the RS485 net (1-250)

Func – Function code = 3

start addr H - MSByte of the address of the parameter:

start addr L - LSByte of the address of the parameter

N.regs H - MSByte of the number of registers to read (always 0)

N.regs L - LSByte of the number of registers to read

CRC16H - MSByte of CRC16

CRC16L - LSByte of CRC16

EU/US	Register Number	Description	Type	R/W	Measurement Unit	Values
EU measurement unit	0	Product Code	-	R	-	7500
	1	ID	-	R	-	1 ÷ 250
	2	MSB Heating Energy	integer	R	kWh	
	3	LSB Heating Energy		R		
	4	MSB Cooling Energy	integer	R	kWh	
	5	LSB Cooling Energy		R		
	6	MSB 1 st Pulse Input Counter	fixed-point (1 decimal)	R	m ³	
	7	LSB 1 st Pulse Input Counter	fixed-point (1 decimal)	R	m ³	
	8	MSB 2 nd Pulse Input Counter		R		
	9	LSB 2 nd Pulse Input Counter	fixed-point (1 decimal)	R	m ³	
	10	MSB 3 rd Pulse Input Counter		R		
	11	LSB 3 rd Pulse Input Counter	fixed-point (1 decimal)	R	m ³ o kWh	
	12	MSB 4 th Pulse Input Counter		R		
	13	LSB 4 th Pulse Input Counter	fixed-point (1 decimal)	R	m ³ o kWh	
	14	Instantaneous Power		R		
	15	Instantaneous Flow	fixed-point (2 decimals)	R	m ³ /h	
	16	Flow Temperature	fixed-point (1 decimal)	R	°C	
	17	Return Temperature	fixed-point (1 decimal)	R	°C	
	18	Temperature Difference	fixed-point (1 decimal)	R	°C	
	19	Alarm / Status	-	R	-	- bit 0: Error on flow temperature - bit 1: Error on return temperature - bit 6: Low battery alarm - bit 8: Measurement unit mismatch on main counter - bit 9: Measurement unit mismatch on counter 1 - bit 10: Measurement unit mismatch on counter 2 - bit 11: Measurement unit mismatch on counter 3 - bit 12: Measurement unit mismatch on counter 4 - bit 2-3-4-5-7-13-14-15: not defined
	20	MSB Secondary Address	-	R	-	Device Serial Number
	21	LSB Secondary Address	-	R	-	
	22	Minute	integer	R	-	0 ÷ 59
	23	Hour	integer	R	-	0 ÷ 23
	24	Day	integer	R	-	1 ÷ 31
	25	Month	integer	R	-	1 ÷ 12
	26	Year	integer	R	-	-
	27	MSB Heating Mass Counter	integer	R	m ³	
	28	LSB Heating Mass Counter		R		
	29	MSB Cooling Mass Counter	integer	R	m ³	
	30	LSB Cooling Mass Counter		R		
	31	Maximum Instantaneous Power	integer	R	kW	
	32	Maximum Instantaneous Flow	fixed-point (1 decimal)	R	m ³ /h	
	33	Tamper Counter	integer	R	-	
34	Firmware Version	-	R	-		

EU/US	Register Number	Description	Type	R/W	Measurement Unit	Values
US measurement unit	100	Product Code	-	R	-	7500
	101	ID	-	R	-	1 ÷ 250
	102	MSB Heating Energy	integer	R	kBtu	
	103	LSB Heating Energy		R		
	104	MSB Cooling Energy	integer	R	kBtu	
	105	LSB Cooling Energy		R		
	106	MSB 1 st Pulse Input Counter	fixed-point (1 decimal)	R	kGAL	
	107	LSB 1 st Pulse Input Counter	fixed-point (1 decimal)	R	kGAL	
	108	MSB 2 nd Pulse Input Counter		R		
	109	LSB 2 nd Pulse Input Counter	fixed-point (1 decimal)	R	kGAL o kBtu	
	110	MSB 3 rd Pulse Input Counter		R		
	111	LSB 3 rd Pulse Input Counter	fixed-point (1 decimal)	R	kGAL o kBtu	
	112	MSB 4 th Pulse Input Counter		R		
	113	LSB 4 th Pulse Input Counter	fixed-point (1 decimal)	R	kBTU/h	
	114	Instantaneous Power		R		
	115	Instantaneous Flow	fixed-point (1 decimal)	R	gpm	
	116	Flow Temperature	fixed-point (1 decimal)	R	°F	
	117	Return Temperature	fixed-point (1 decimal)	R	°F	
	118	Temperature Difference	fixed-point (1 decimal)	R	°F	
	119	Alarm / Status	-	R	-	- bit 0: Error on flow temperature - bit 1: Error on return temperature - bit 6: Low battery alarm - bit 8: Measurement unit mismatch on main counter - bit 9: Measurement unit mismatch on counter 1 - bit 10: Measurement unit mismatch on counter 2 - bit 11: Measurement unit mismatch on counter 3 - bit 12: Measurement unit mismatch on counter 4 - bit 2-3-4-5-7-13-14-15: not defined
	120	MSB Secondary Address	-	R	-	Device Serial Number
	121	LSB Secondary Address	-	R	-	
	122	Minute	integer	R	-	0 ÷ 59
	123	Hour	integer	R	-	0 ÷ 23
	124	Day	integer	R	-	1 ÷ 31
	125	Month	integer	R	-	1 ÷ 12
	126	Year	integer	R	-	-
	127	MSB Heating Mass Counter	integer	R	kGAL	
	128	LSB Heating Mass Counter		R		
	129	MSB Cooling Mass Counter	integer	R	kGAL	
	130	LSB Cooling Mass Counter		R		
	131	Maximum Instantaneous Power	integer	R	kBTU/h	
	132	Maximum Instantaneous Flow	fixed-point (1 decimal)	R	gpm	
	133	Tamper Counter	integer	R	-	
134	Firmware Version	-	R	-		

Ci riserviamo il diritto di apportare miglioramenti e modifiche ai prodotti descritti ed ai relativi dati tecnici in qualsiasi momento e senza preavviso.



Caleffi S.p.A.
S.R. 229 n. 25 · 28010 Fontaneto d'Agogna (NO) · Italia
Tel. +39 0322 8491 · Fax +39 0322 860064