

CODE NUMBER

3141615

DESCRIPTION

3.5 gpf, Rough Brass Finish, Single Flush, 1" Straight Control Stop, 4.75 L Dimension, Naval Concealed Manual Water Closet Flushometer.

DETAILS

- Flush Volume: 3.5 gpf (13.2 Lpf)
- Finish: Rough Brass (RB)
- Valve: Piston
- Valve Body Material: Semi-red Brass
- Fixture Type: Water Closet
- Fixture Connection: Rear spud
- Spud Coupling: 1 ½" (38mm)
- Supply Pipe: 1" (25mm)
- L Dimension: 4 ¾" (121mm) (4-3/4-LDIM)
- Control Stop: 1" Straight (E)

FEATURES

- Non-hold-open oscillating handle, Bak-Chek™ control stop and self-cleaning Xpelor Metering By-Pass ensure reliable operation and accurate flush delivery
- Available with adjustable or ground joint supply stop (ground joint recommended for salt water applications)
- Factory set flush volume of either 1.6 gpf/6.0 Lpf or 3.5 gpf/13.2 Lpf with adjustment range of 1.5 gpf/5.7 Lpf to 7.0 gpf/26.5 Lpf
- Valve body, Cover, Tailpiece and Control Stop shall be in compliance with ASTM Alloy Classification for Red Brass
- Valve shall be in compliance to the applicable sections of ASSE 1037.

**COMPLIANCES & CERTIFICATIONS**

(UPC Certified, BAA Compliant)

RECOMMENDED SPECIFICATION

Valve Body, Cover, Tailpiece and Control Stop shall be in conformance with ASTM Alloy Classification for Semi- Red Brass. Valve shall be in compliance with the applicable sections of ASSE 1037 and ANSI/ASME 112.19.2.

VALVE OPERATING PRESSURE (FLOWING)

15–80 PSI (103–552 kPa). Specific fixtures may require greater minimum flowing pressure - consult manufacturer requirements.

DOWNLOADS

- [Naval Piston Type Exposed Installation Instructions](#)
- [Control Stop Repair and Maintenance Guide](#)
- [Flush Connections Flanges Repair and Maintenance Guide](#)
- [Tail Piece Repair and Maintenance Guide](#)
- [Concealed Flushometers Repair and Maintenance Guide](#)
- [Additional Downloads](#)

NOTES

All information contained within this document subject to change without notice.

Looking for other variations of the NAVAL 152 product? [View the general spec sheet with all options.](#)

[Find a compatible urinal](#) for this flushometer.

[Find a compatible water closet](#) for this flushometer.

Sloan 10500 Seymour Ave, Franklin Park, IL 60131

Phone: 800.982.5839 • Fax: 800.447.8329 • sloan.com

ROUGH-IN

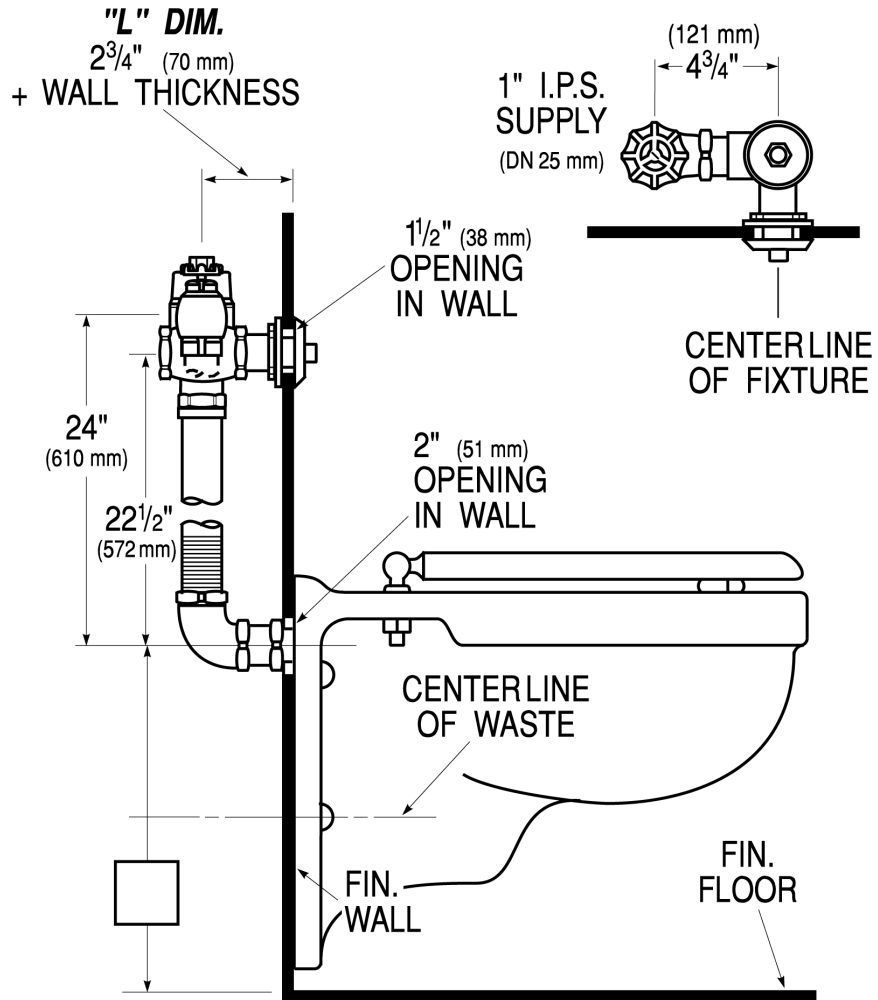

Sloan 10500 Seymour Ave, Franklin Park, IL 60131
 Phone: 800.982.5839 • Fax: 800.447.8329 • sloan.com