

133-MAS3-JA6

Lavatory Angle Stop Kit

1/2" Sweat x 3/8" OD Compression

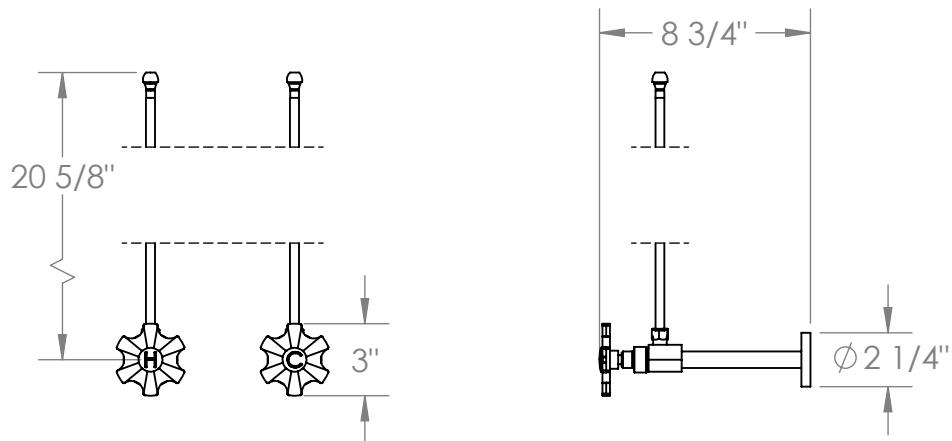

Meets the applicable requirements of ASME A112.18.1-2005/CSA B125.1-05, entitled "Plumbing Supply Fittings"

WATERMARK DESIGNS 7/29/2020

350 Dewitt Ave Brooklyn NY 11207 USA T 718 257 2800 F 718 257 2144 info@watermark-designs.com