

**321-MAS6-\_\_**  
Toilet Angle Stop Kit  
1/2" IPS x 3/8" OD Compression

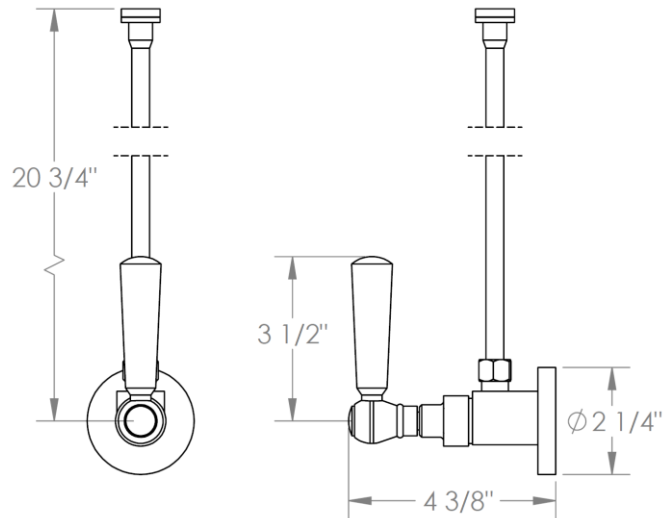

HANDLE TRIM OPTIONS

S1 - PRESTON

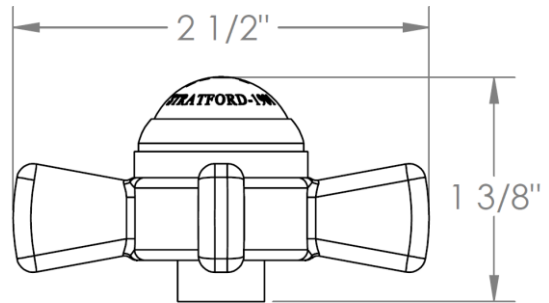

S2 - WALTHAM

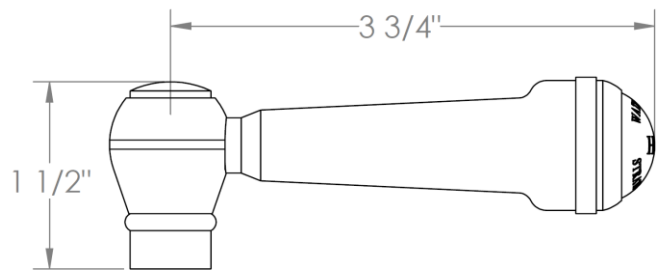

SWA - DARIEN

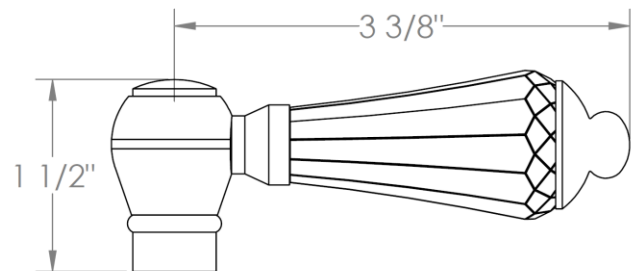

V - WALES

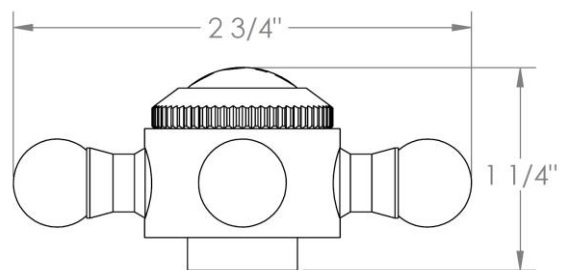

S1A – NOTTINGHAM

