

**37-MAS5-BL2**

Toilet Angle Stop Kit

1/2" Compression x 3/8" OD Compression

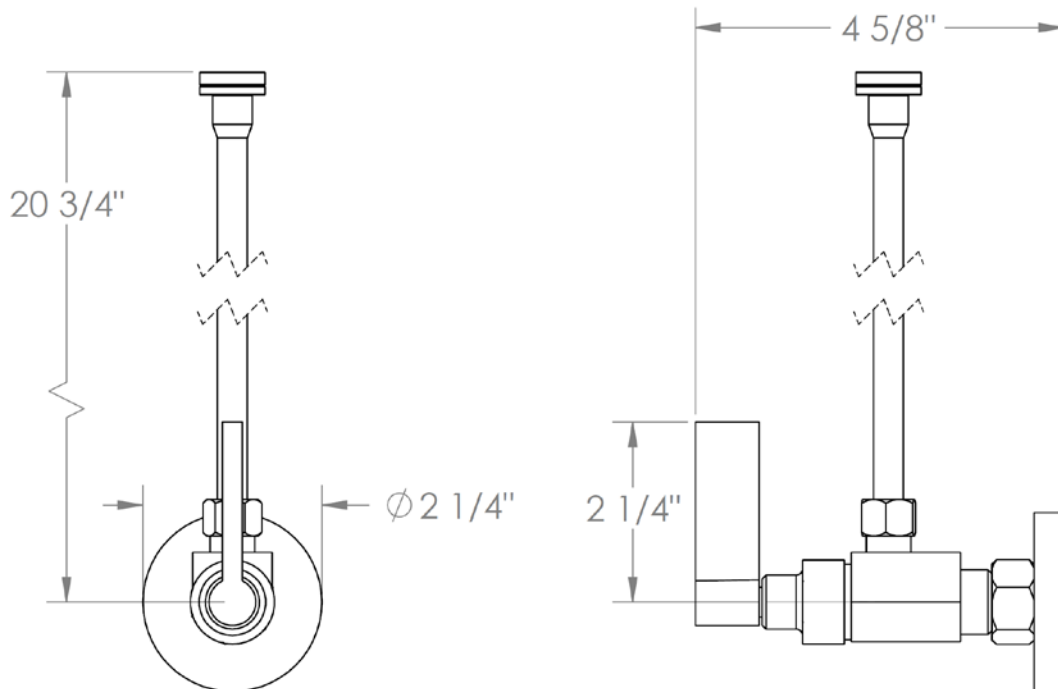
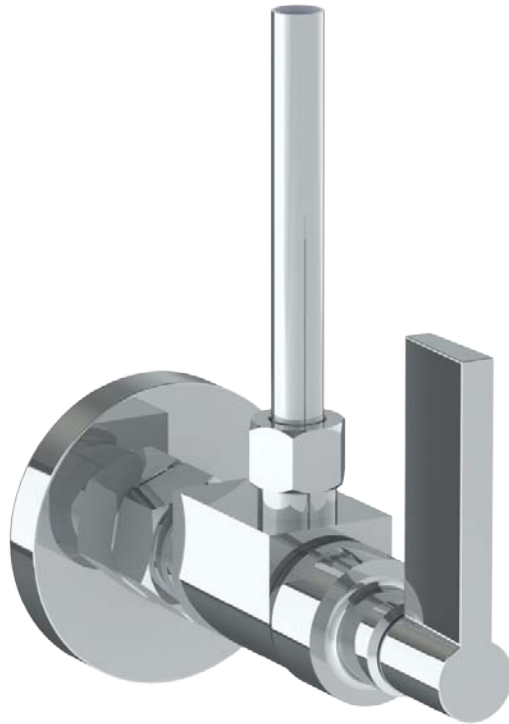

Meets the applicable requirements of ASME A112.18.1-2005/CSA B125.1-05, entitled "Plumbing Supply Fittings"

**WATERMARK DESIGNS 2/16/2018**

350 Dewitt Ave Brooklyn NY 11207 USA T 718 257 2800 F 718 257 2144 info@watermark-designs.com