

Application

The Zurn Wilkins Model ZW209FP Pilot Operated Pressure Reducing Valve is designed specifically for Fire Suppression Systems to reduce high inlet pressures to a safe and stable outlet pressure. The pilot assembly reacts to changes in downstream pressure allowing the main valve to modulate between the closed and open position ensuring a constant downstream set pressure. Once the downstream pressure reaches the pilot setting, the main valve will seal shut preventing damage downstream. Pressure regulation is not dependent upon flow rate, resulting in minimal pressure loss through the valve. In addition the Model ZW209FP comes standard with red epoxy coating internally and externally for corrosion protection, as well as isolation valves and pressure gauges for quick and easy maintenance or repair. The Zurn Wilkins Model ZW209FP is available in both globe and angle pattern bodies.

Approvals

- UL and C-UL Listed (1-1/4" thru 10")



Materials

Main Valve Body	Ductile Iron ASTM A536
Main Valve Cover	Ductile Iron ASTM A536
Disc Guide	Stainless Steel
Seat	Stainless Steel
Disc	Buna-N Rubber
Diaphragm	Nylon Reinforced Buna-N
Stem	Stainless Steel
Spring	Stainless Steel

Standard Features

- "Wye" Type Strainer
- Inlet and Outlet Pressure Gauges (UL/FM)
- 3-Way Gauge Isolation Valves
- Red Epoxy Coated, FDA Approved
- Copper Tubing and Brass Fittings

Sizes

Globe and Angle Style Body:	
Flanged ends	<input type="checkbox"/> 1 1/2" thru 10"
Grooved ends	<input type="checkbox"/> 1 1/2" thru 10"
Threaded ends	<input type="checkbox"/> 1 1/4" thru 3"
Temperature Rating:	<input type="checkbox"/> Water 33°F to 140°F
Pilot Spring Range:	<input type="checkbox"/> 50-165 psi Residual Pressure (155 psi Max 10")

Standards And Pressure Ratings

	Standards Compliance	UL Pressure Ratings
Main Body	ANSI/AWWA C530	
Flanged	CLASS 150 - ANSI B16.42	250 psi
	CLASS 300 - ANSI B16.42	300 psi
Grooved	IPS - AWWA C606	300 psi
Threaded	NPT - ANSI B1.20.1	300 psi

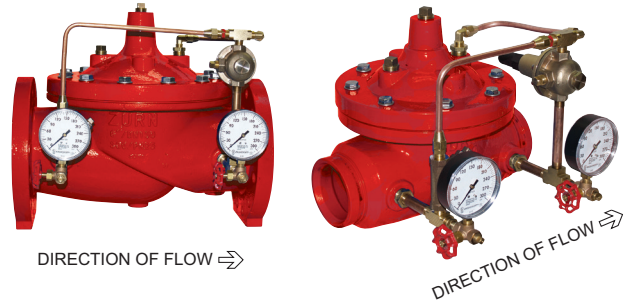

Options

(Add suffix letters to ZW209FP)

Function

- C - 40XL Hydraulic Check

Body

- A - Angle Style Body

Connections

- G - Grooved Ends (inlet rating 300 psi)
- TH - NPT threaded (inlet rating 300 psi)
- Y - ANSI Class 300 Flanged (inlet rating 300 psi)
- X - ANSI Class 150 Flanged (inlet rating 250 psi)

Pilot System

- ST - Stainless Steel Tubing (included with SP option, only replaces Copper Tubing)
- SP - All Stainless Steel Pilotry (replaces all brass fittings, pilot valve and copper tubing)
- RV - Pilot on Reverse Side

Schematic Diagram

Item	Description of Standard Features
1.	Main Valve
2.	SXL "Wye" Type Strainer
3.	Pressure Gauge
4.	Restriction Fitting
5.	PV-PRD Pressure Reducing Control
C.	40XL Hydraulic Check

Model ZW209FPG

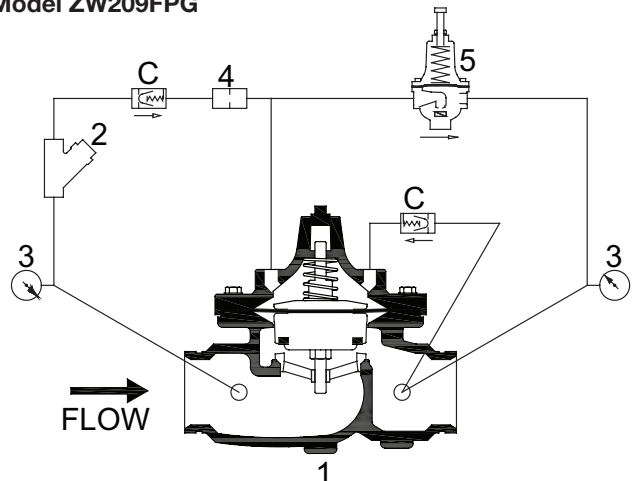

Refer to www.zurn.com for updated information.

Globe and Angle Main Valve Dimensions

DIM	FULL PORT	VALVE SIZE INCHES (mm)								
		1 1/4 (32)	1 1/2(38)	2 (50)	2 1/2 (65)	3 (80)	4 (100)	6 (150)	8 (200)	10 (250)
A	Threaded	7 1/4	7 1/4	9 7/16	11	2 1/2				
	Class 150 Flange		8 1/2	9 3/8	11	12	15	20	25 3/8	29 3/4
	Class 300 Flange		9	10	11 5/8	13 1/4	15 5/8	21	26 7/16	31 1/8
	Grooved		8 1/2	9	11	12 1/2	15	20	25 3/8	29 3/4
B	Diameter	5 5/8	5 5/8	6 3/4	8	9 3/16	11 11/16	15 3/4	20 1/8	23 11/16
C	Max.	5 3/4	5 3/4	6 3/16	7 3/8	8	10 3/16	12 5/16	15 9/16	17 5/8
D	Threaded/Grooved	1 3/8	1 3/8	1 3/4	2 1/8	2 9/16	3 7/16	5	5	5 13/16
	Class 150 Flange		2 1/2	3	3 1/2	3 3/4	4 1/2	5 1/2	6 3/4	8
	Class 300 Flange		3	3 1/4	3 3/4	4 1/8	5	6 1/4	7 1/2	8 3/4
E	NPT Body Tap	3/8	3/8	3/8	1/2	1/2	3/4	3/4	1	1
F	NPT Cvr. Plug Tap	1/2	1/2	1/2	1/2	1/2	3/4	3/4	1	1
G	NPT Cover Tap	3/8	3/8	3/8	1/2	1/2	3/4	3/4	1	1
H	Threaded	3 1/4	3 1/4	4 3/4	5 1/2	6 1/4				
	Class 150 Flange		4	4 3/4	5 1/2	6	7 1/2	10	12 11/16	14 7/8
	Class 300 Flange		4 1/4	5	6	6 7/16	8	10 1/2	13 1/4	15 9/16
	Grooved		4 7/16	4 3/4	5 1/2	6	7 1/2	10	12 11/16	14 7/8
J	Threaded	1 15/16	1 15/16	3 1/4	4	4 1/2				
	Class 150 Flange		4	3 1/4	4	4	5	6	8	8 5/8
	Class 300 Flange		4 1/4	3 1/2	4 5/16	4 7/16	5 1/6	6 1/2	8 1/2	9 5/16
	Grooved		3 3/16	3 1/4	4	4 1/4	5	6	8	8 5/8
Valve Stem Internal Thread		10-32	10-32	10-32	10-32	1/4-20	1/4-20	1/4-20	3/8-16	3/8-16
Stem Travel (in)		7/16	7/16	3/4	7/8	1	1 3/16	1 3/4	2 3/8	2 13/16
Approx. Wt. (lbs)		22	26	36	55	70	130	240	440	720

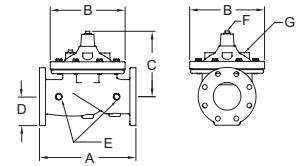

Globe Style Body

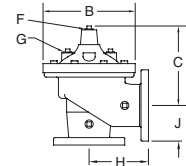

Angle Style Body

Pilot System Dimensions

PILOT SYSTEM DIMENSIONS			VALVE SIZE INCHES (mm)								
	DIM		1-1/4 (32)	1-1/2 (40)	2" (50)	2-1/2" (65)	3" (80)	4" (100)	6" (150)	8" (200)	10" (250)
Full Port Body	X	Max. (inches)	8 1/2	8 1/2	8 1/2	8 1/2	9 1/2	12	13	14	15 3/4
	Y	Max. (inches)	4	4	3 1/2	4	4 1/2	6	8	10	12
	Z	Max. (inches)	8 1/2	8 1/2	9	9	9 1/2	10	11 1/2	13	14 1/2
Angle Body	W	Max. (inches)	7 1/2	7 1/2	7 1/2	7 1/2	7 1/2	7 1/2	10	13	15
	X	Max. (inches)	8 1/2	8 1/2	8 1/2	8 1/2	9 1/2	12	13	14	17 1/2
	Y	Max. (inches)	5	5	5	5	5	5 13/16	7 7/8	10	12
	Z	Max. (inches)	9	9	9 1/2	9 1/2	10	10 1/2	12	13 1/2	15

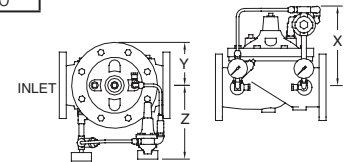

Globe Pilot System Dimensions

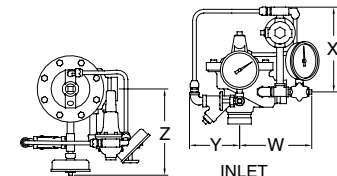

Angle Pilot System Dimensions

Flow Characteristics

BODY MINIMUM FRICTION LOSS

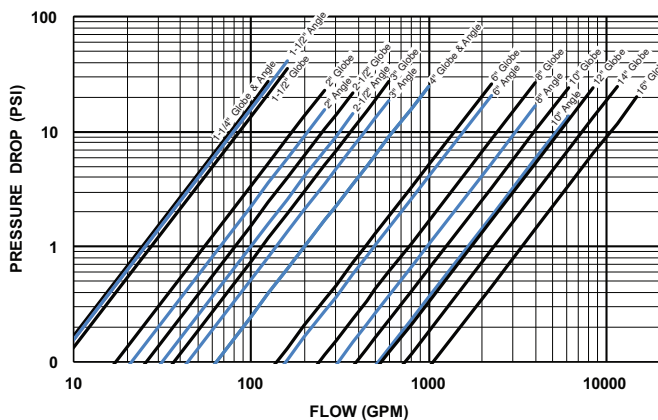

PRESSURE REDUCTION LIMIT

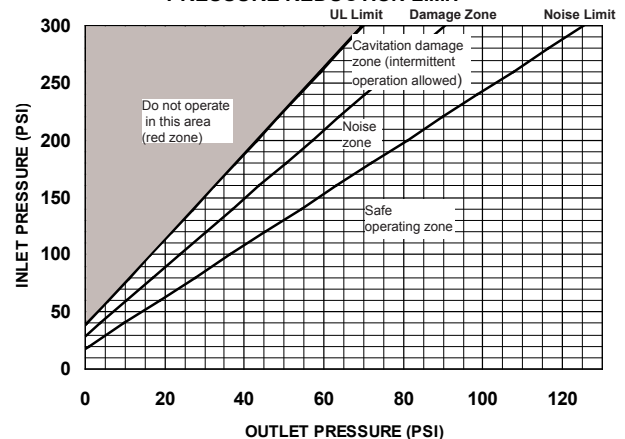

See Instruction Sheet at www.zurn.com for more setting information.

* Notes for Body Minimum Friction Loss Chart:

Minimum inlet pressure is 10 psi higher than set point or the additional body friction loss at intended flow, whichever is higher. (friction loss may be important at flows above 20 ft/s)

Example: A 6" valve intended to flow 2000 GPM at 150 psi has a friction loss of 20 psi at 2000 GPM. The minimum inlet pressure would be 150 + 20 = 170 psi. When inlet pressure is below set point, the outlet pressure will be the pressure at the inlet minus the friction loss.

Valve Size	NPS (inches)	1 1/4	1 1/2	2	2 1/2	3	4	6	8	10
	DN (mm)	32	38	50	65	80	100	150	200	250
Min Flow Rate to set Valve* (GPM)		15	15	100	35	60	100	220	400	600
Min Flow Rate (GPM)		1	1	1	2	2	4	10	15	35
Max Flow Rate (GPM)		125	160	250	375	600	1000	2250	4000	6000

Flow calculations are based on flow through schedule 40 Pipe. Maximum continuous flow is approximately 20 ft./sec (6.1 meters/sec). Maximum intermittent flow is 25 ft./sec (7.6 meters/sec). The actual capacity is limited by available differential pressure.

Operation

The Model ZW209FP utilizes a pressure reducing pilot valve that installs on the discharge side of the control circuitry. The pilot is a direct acting, normally open, spring loaded, diaphragm actuated valve. The operation of the ZW209FP begins with accurately sizing the valve, then fine tuning the control circuit by adjusting the pilot spring to the desired downstream pressure. Inlet pressure is piped to the inlet port of the pressure reducing pilot. A sensing line runs internally from the discharge side of the pilot to its lower control chamber under the diaphragm. Thus, downstream pressure exceeding the preset acts to close the pilot while the adjustable spring seeks to keep it open. The result is a modulating action in the pilot that is transmitted to the cover of the main valve. This creates a mirror modulation of the diaphragm assembly in the main valve. Downstream pressure is maintained within narrow limits regardless of changing flow rates or varying inlet pressures.

Typical Installation

The upstream and downstream pressure gauges are required by Underwriters Laboratories® (UL). Also a relief valve of not less than 1/2" in size MUST be installed on the downstream side of the pressure control valve. Adequate drainage for the relief valve discharge must be provided.

UI Installation Specification Requirements

UL installation specifications require the valve to be installed in accordance with the standard for installation of sprinkler systems, NFPA 13, or the standard for installation of standpipes and hose systems, NFPA 14. The valve is to be inspected, tested and maintained in accordance with the standard for the Inspection, Testing and Maintenance of Water-Based Fire Protection Systems, NFPA 25.

Typical Installation

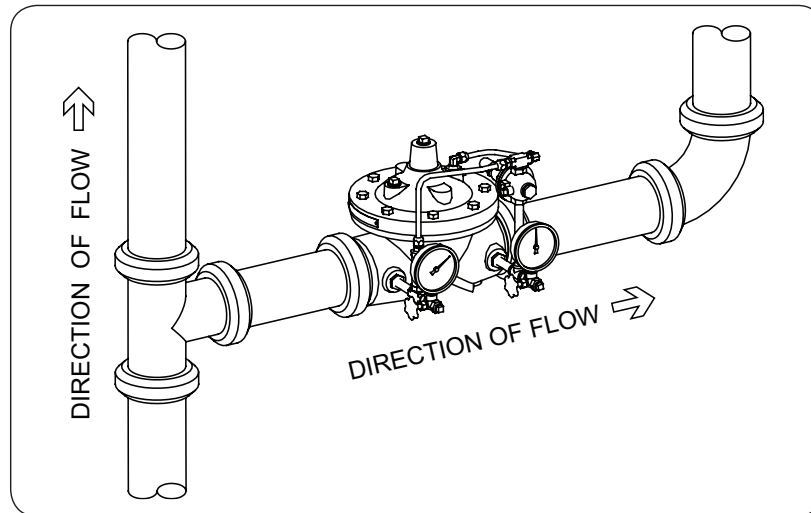

Specifications

The Pressure Reducing Valve shall be a diaphragm actuated, pilot controlled. The main valve body shall be Ductile Iron ASTM A 536. The stem of the basic valve shall be guided top and bottom. The diaphragm shall not be used as a seating surface. All internal and external ferrous surfaces shall be coated with a high quality, fusion epoxy coating. The pilot control shall consist of a two-way, normally open, direct acting, adjustable spring loaded, diaphragm actuated pressure reducing pilot. The pilot control shall be field adjustable from 50 psi to 165 psi. The Pressure Reducing Valve shall be a ZURN WILKINS Model ZW209FP.

Job Name _____ **Contractor** _____

Job Location _____ **Engineer** _____