



# Model ZW4004

## Pressure-Tru™ Automatic Fire Control

### Application

The Pressure-Tru™ ZW4004 Series Pressure Reducing Valve is listed as a floor control valve, an indicating valve, and a check valve in automatic sprinkler systems as well as a standpipe valve for CLASS I and CLASS III systems. Regulates pressure under both flow and no-flow conditions.

### Standards Compliance

- UL® Listed
- C-UL® Listed
- NYC MEA 325-06-E
- City of Los Angeles Approved
- SS option - California State Fire Marshall Listed

### Material

Castings/internals Cast bronze ASTM B 584  
Elastomers Buna Nitrile (FDA approved)  
EPDM (FDA approved)

### Features

Sizes: 2 1/2"  
Maximum inlet pressure 400 psi  
End connections (FNPT) ANSI B1.20.1  
(Grooved) AWWA C606  
Factory Set  
Tapped & plugged inlet and outlet for pressure gauge



ZW4004ILMSA



ZW4004GMSA

### Options

(Suffixes can be combined)

- angle type valve
- IL - in-line (globe type) valve
- G - with grooved inlet and outlet connections
- SS - with integral supervisory switch, contact rating 3 amps @ 125 VAC and tamper resistant cover
- MSA - with monitor switch adapter
- CAP - with capped bonnet, no handwheel assembly
- CH - with chrome finish

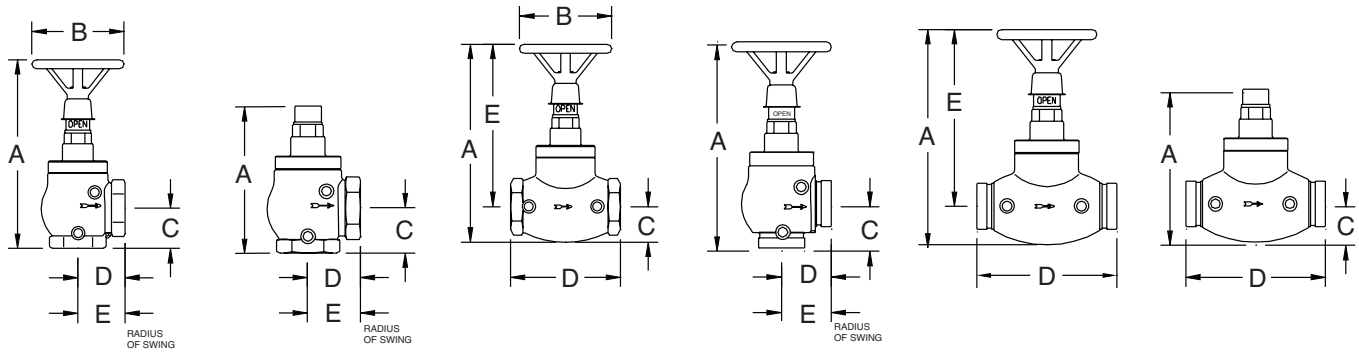

ZW4004

ZW4004CAP

ZW4004IL

ZW4004G

ZW4004ILG

ZW4004ILGCAP

### Dimensions & Weights (do not include pkg.)

MODEL	DIMENSIONS (approximate)												WEIGHT	
	A OPEN		A CLOSED		B		C		D		E			
	in.	mm	in.	mm	in.	mm	in.	mm	in.	mm	in.	mm	lbs	kg
ZW4004	12 7/8	327	12	305	6 1/4	159	2 3/4	70	3 3/16	92	3 5/8	92	20	9
ZW4004IL	13 1/2	343	12 1/2	318	6 1/4	159	2 3/8	60	7 1/2	191	8 3/16	208	24	11
ZW4004G	13 5/16	338	12 7/16	316	6 1/4	159	3 3/16	81	3 3/16	81	n/a	n/a	19	8.6
ZW4004ILG	13 1/2	343	12 1/2	318	6 1/4	159	2 3/8	60	8 3/4	222	n/a	n/a	24	11
ZW4004CAP	9	229	n/a	n/a	n/a	n/a	2 3/4	70	3 3/16	81	3 5/8	92	16	7
ZW4004ILCAP	7 1/4	184	n/a	n/a	n/a	n/a	2 3/8	60	7 1/2	191	7 1/4	184	20	9

# Residual Pressure Charts

For Pressure-Tru® 2 1/2" Models: ZW4000, ZW4000G, ZW4004 & ZW4004G

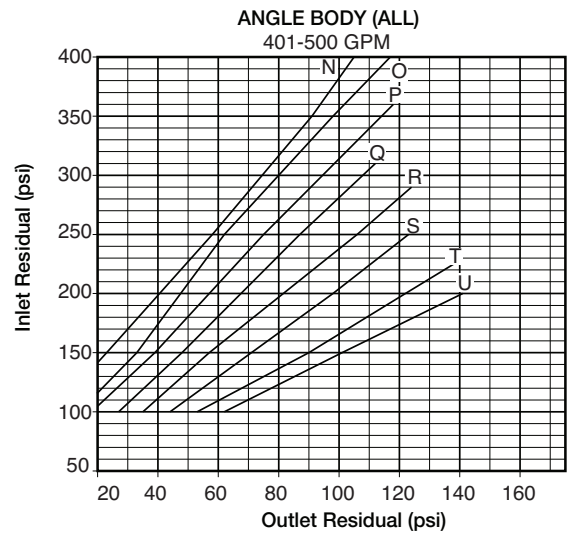
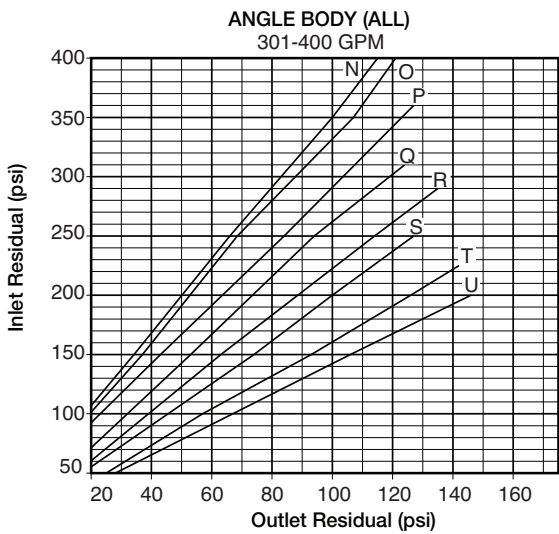
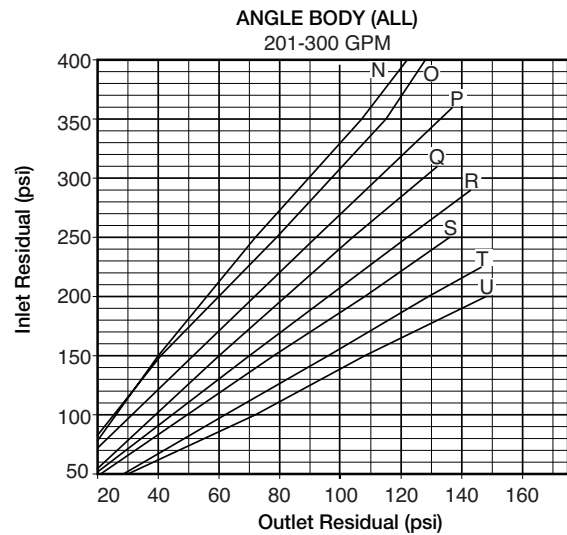
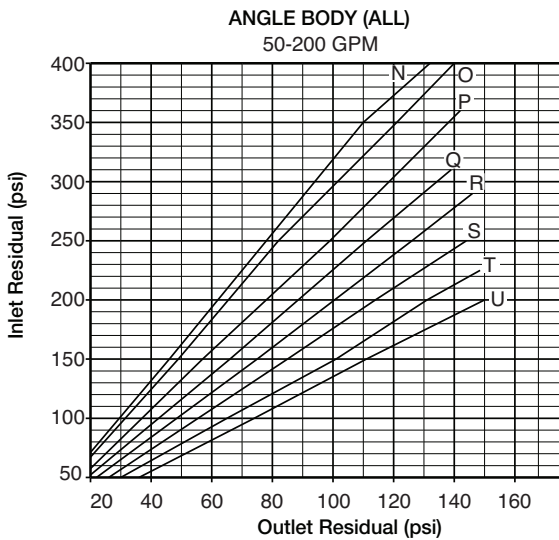

## Choosing The Correct Settings

In designing a sprinkler system, a minimum of 20 psi pressure differential (the difference between the inlet static pressure and the valve outlet set static pressure) is recommended to assure a well regulated and efficient system. In choosing the correct setting for the Pressure-Tru® valve, refer to the Residual Pressure Charts, Static Pressure Chart and the following procedures:

1. Determine the demand in gallons per minute required downstream of the valve.
2. Determine the standpipe residual or "flow pressure" at the valve inlet.
3. Locate the appropriate flow chart based on GPM required and body style.
4. Locate the inlet residual pressure on the vertical axis of the chart and draw a horizontal line from this pressure across the chart.
5. Locate the desired valve outlet residual pressure on the horizontal axis of the chart and draw a vertical line from this pressure.
6. The curve nearest the intersection of the two lines drawn is the appropriate type for the valve.
7. To determine the static outlet pressure, locate the static chart. Determine the valve inlet static pressure shown on the vertical axis and draw a horizontal line from that pressure to the appropriate curve determined above, then draw a vertical line down to the horizontal axis and read the static outlet pressure.

## Maximum Rated Inlet Pressure

Maximum inlet pressure, to assure a maximum outlet pressure of 175 psi. Inlet side of valves can be safely tested up to 400 PSI during system hydrostatic leak test.

Bonnet Type	Max Inlet Pressure psi (kpa)	
N	400	(2750)
O	400	(2750)
P	360	(2475)
Q	310	(2125)
R	290	(2000)
S	250	(1725)
T	225	(1550)
U	200	(1375)

# Residual Pressure Charts

For Pressure-Tru® 2 1/2" Models: ZW4000IL & ZW4004IL

INLINE BODY (NPT)  
50-100 GPM

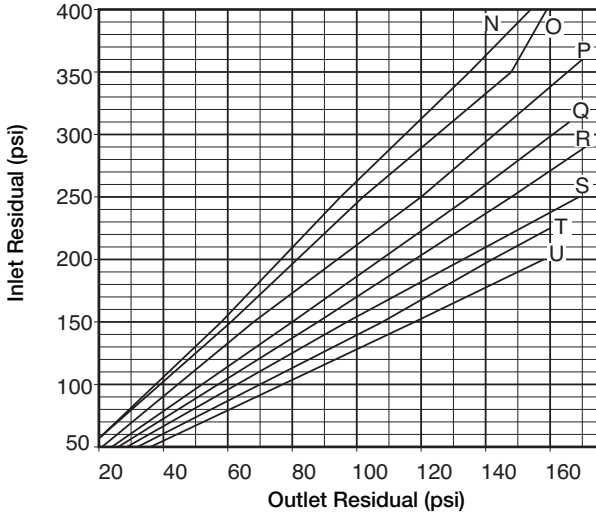

INLINE BODY (NPT)  
101-200 GPM

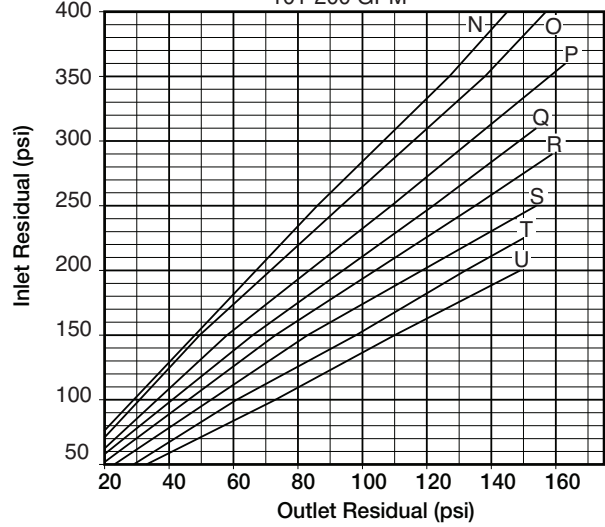

INLINE BODY (NPT)  
201-300 GPM

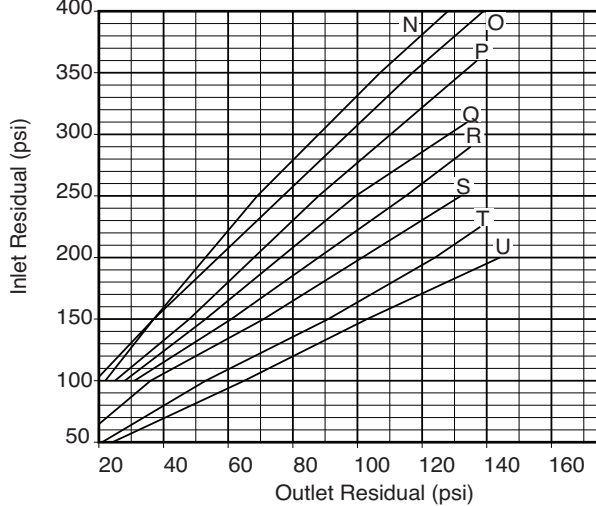

INLINE BODY (NPT)  
301-400 GPM

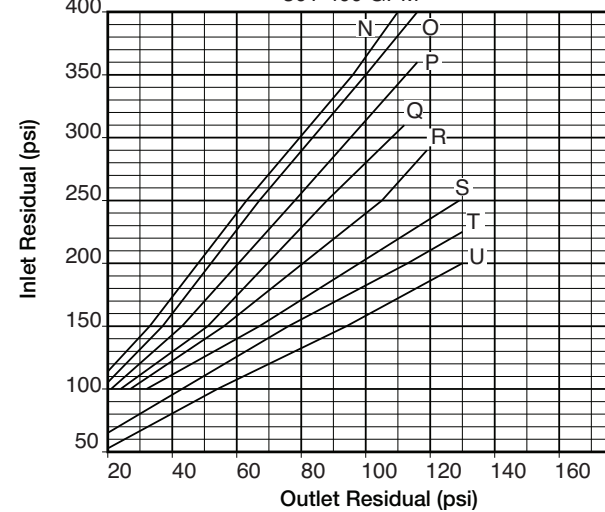

INLINE BODY (NPT)  
401-500 GPM

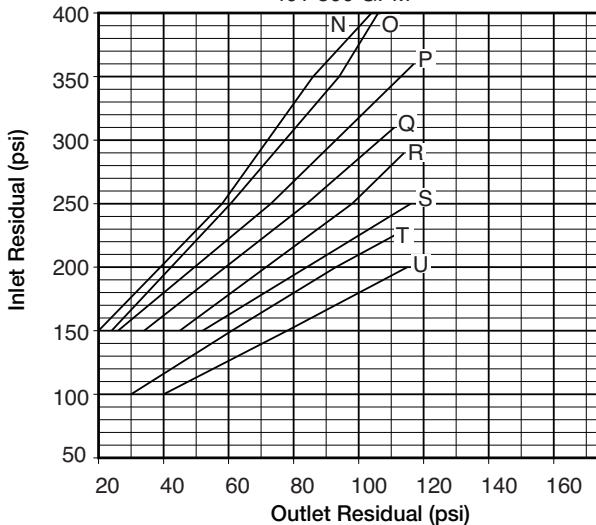

ANGLE & INLINE BODIES (ALL)  
STATIC CHART

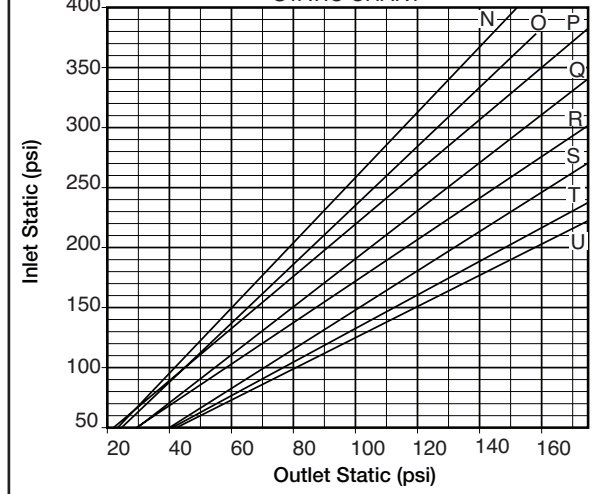

# Residual Pressure Charts

For Pressure-Tru® 2 1/2" Models: ZW4000ILG & ZW4004ILG

INLINE BODY (GROOVED)  
50-100 GPM

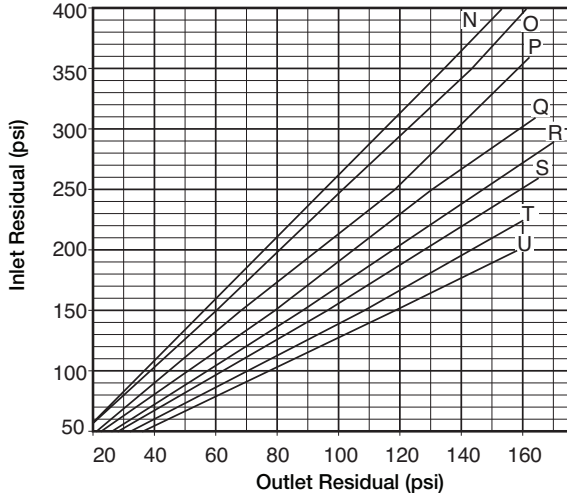

INLINE BODY (GROOVED)  
101-200 GPM

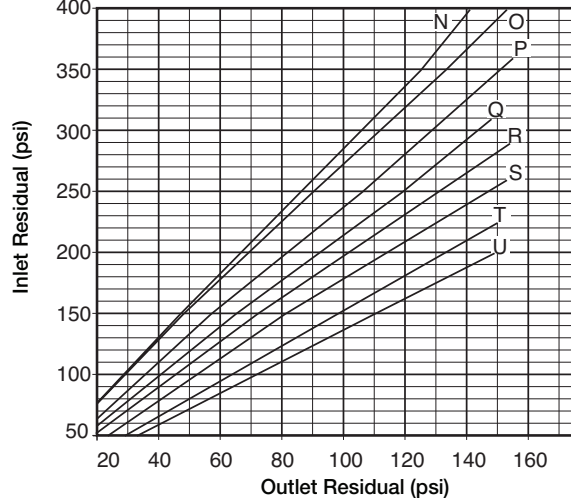

INLINE BODY (GROOVED)  
201-300 GPM

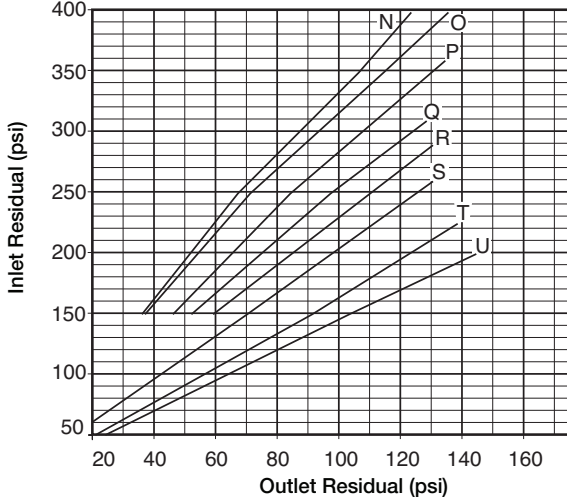

INLINE BODY (GROOVED)  
301-400 GPM

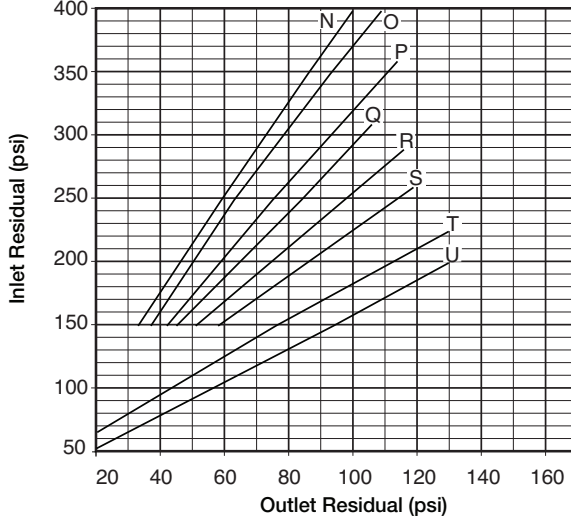

INLINE BODY (GROOVED)  
401-500 GPM

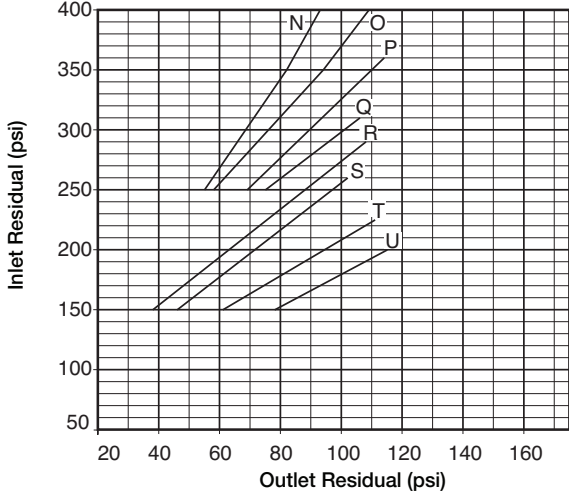

Proper performance is dependent upon licensed, qualified personnel performing regular, periodic testing according to ZURN WILKINS' specifications and prevailing governmental & industry standards and codes and upon following these installation instructions. Failure to do so releases ZURN WILKINS of any liability that it might otherwise have with respect to that device. Such failure could also result in an improperly functioning device.